



VERSACE
HOME

VENERE

VENERE

PAVIMENTI & RIVESTIMENTI

LA PUREZZA DELLE FORME, LA BELLEZZA OLTRE IL TEMPO.

Vivere sulla superficie di un sogno, su spazi immaginati per essere belli al di là delle mode. Dall'unione del classico con l'avanguardia tecnologica nasce Venere, la collezione ideale per una casa dove la bellezza regna sovrana.

FLOORS AND WALLS

THE PURITY OF FORM, BEAUTY BEYOND TIME.

Living on the surface of a dream, on spaces designed to be beautiful beyond fashion. Venus is born from the union of the classic with the avant-garde, the ideal collection for a home where beauty reigns supreme.

SOLS ET REVÊTEMENTS

LA PURETÉ DES FORMES, LA BEAUTÉ AU-DELÀ DU TEMPS

Vivre sur la surface d'un rêve, dans des lieux dont la beauté a été imaginée pour perdurer au-delà des modes. De l'union du classique et de la technologie d'avant-garde est née Venere, la collection idéale pour une habitation où la beauté est reine..

WAND- UND BODENFLIESEN

KLARE FORMEN, ZEITLOSE SCHÖNHEIT

Traumhafte Bodenflächen, Räume, die jenseits aller Moden einfach schön sind. Aus der Verbindung von Klassik und avantgardistischer Technologie entsteht Venere, die ideale Kollektion für Wohnräume, die mit souveräner Ästhetik bestechen.

PAVIMENTOS Y REVESTIMIENTOS

LA PUREZA DE LAS FORMAS, LA BELLEZA ATEMPORAL

Vivir en la superficie de un sueño, en espacios concebidos para ser bellos más allá de las modas. De la unión de lo clásico y la vanguardia tecnológica nace Venere, la colección ideal para una casa donde reina la belleza absoluta.

НАПОЛЬНЫЕ И ОБЛИЦОВочНЫЕ ПОКРЫТИЯ ЧИСТОТА ФОРМ, ВЕЧНАЯ КРАСОТА.

Для жизни – пол нашей мечты в помещениях, которые красивы всегда, независимо от веяний моды. Союз классики с технологическим авангардом породил Venere, идеальную коллекцию для дома, в котором всем правит красота

地砖与墙砖

简约造型，永恒之美

梦幻生活，超越时尚，美丽想象空间。经典与尖端工艺的结合，从而诞生了Venere——完美至上家居的理想选择。



VENERE

BEIGE / ORO

VENERE
BEIGE / ORO 25 x 60
50 x 50



VENERE

MOSAICO BEIGE / ORO / NOCE 25 x 60
LISTELLO GRECA 3x25
TOZZETTO 3x3
TORELLO 4x25



- 1) RIV: BEIGE/ORO 25x60
FASCIA FOGLIA 7,8x60
PAV: ORO 50x50
FASCIA FOGLIA 15,3x50
TOZZETTO FOGLIA 15,3x15,3
- 2) FASCIA FOGLIA ORO 7,8x60





1)

1) BEIGE/ORO 25x60
FASCIA FOGLIA 7,8x60

2) BEIGE 50x50
FASCIA FOGLIA 15,3x50
FASCIA GRECA 4x50



2)



VENERE
ALMOND / BEIGE 50 x 50
FASCIA FOGLIA 15,3x50
ROSONE 100x100

VENERE
ALMOND / BEIGE 50 x 50





VENERE

ALMOND / BEIGE 50 x 50

FASCIA FOGLIA 15,3x50
TOZZETTO FOGLIA 15,3x15,3
FASCIA GRECA 4x50
TOZZETTO GRECA 4x4



VENERE

1)

1) BEIGE 50x50
FASCIA GRECA 4x50

2) BEIGE 50x50
FASCIA FOGLIA 15,3x50



2)



VENERE

ORO

ORO / BEIGE 25 x 60
50 x 50





VENERE

ORO / BEIGE 25 X 60
BOISERIE 25x60
FASCIA FOGLIA 7,8x25
TORELLO 4x25



1) COLONNA 19,7x39,4
TERMINALE COLONNA 8x19,7
2) ORO 50x50
FASCIA FOGLIA 15,3x50





VENERE
ORO 50x50
FASCIA FOGLIA 15,3x50
TOZZETTO FOGLIA 15,3x15,3



- 1) ORO 50x50
FASCIA FOGLIA 15,3x50
TOZZETTO FOGLIA 15,3x15,3
- 2) ORO 50x50
FASCIA FOGLIA 15,3x50
TOZZETTO FOGLIA 15,3x15,3
FASCIA GRECA 4x50

1)

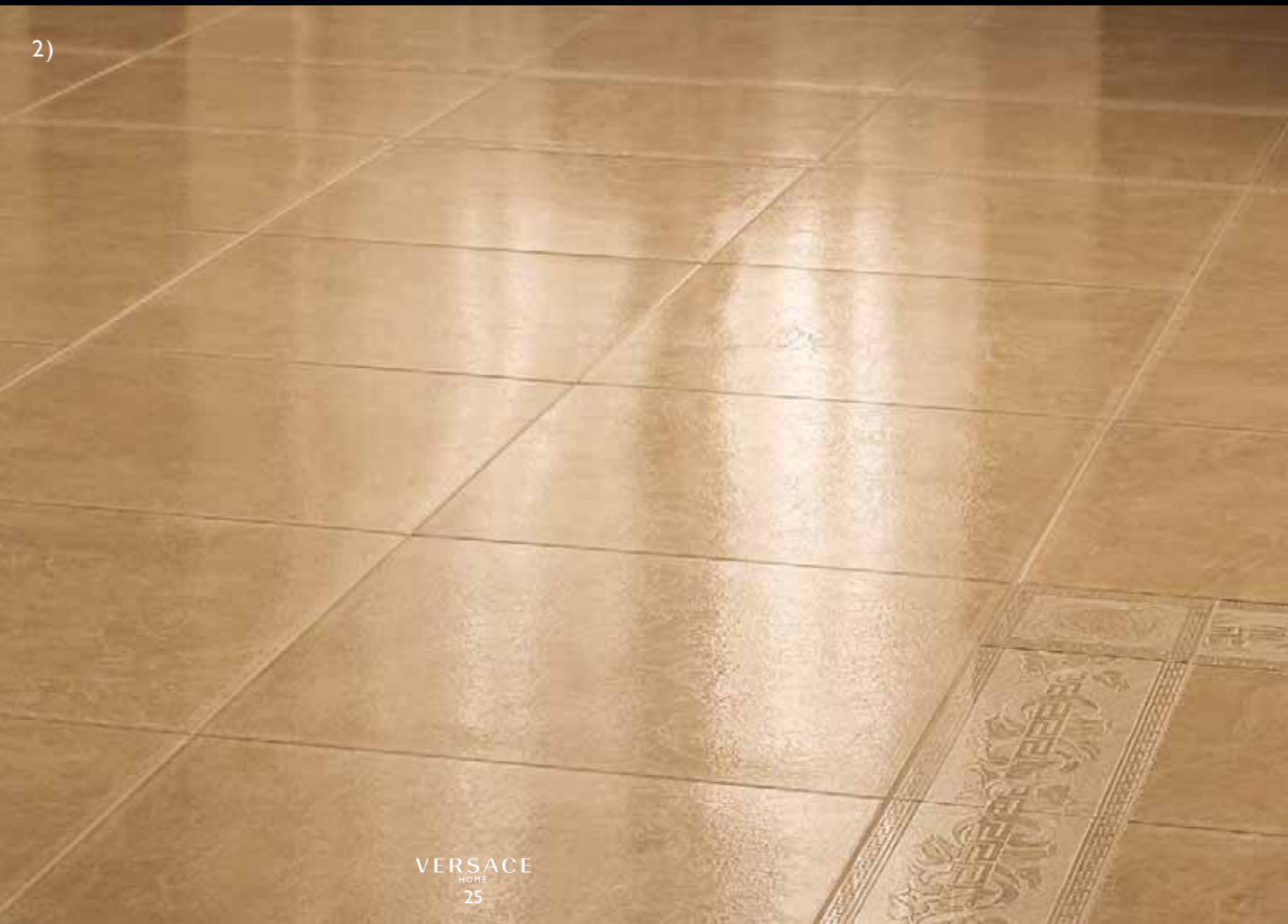

2)



VENERE NOCE

VENERE

NOCE / BEIGE 25 x 60
50 x 50

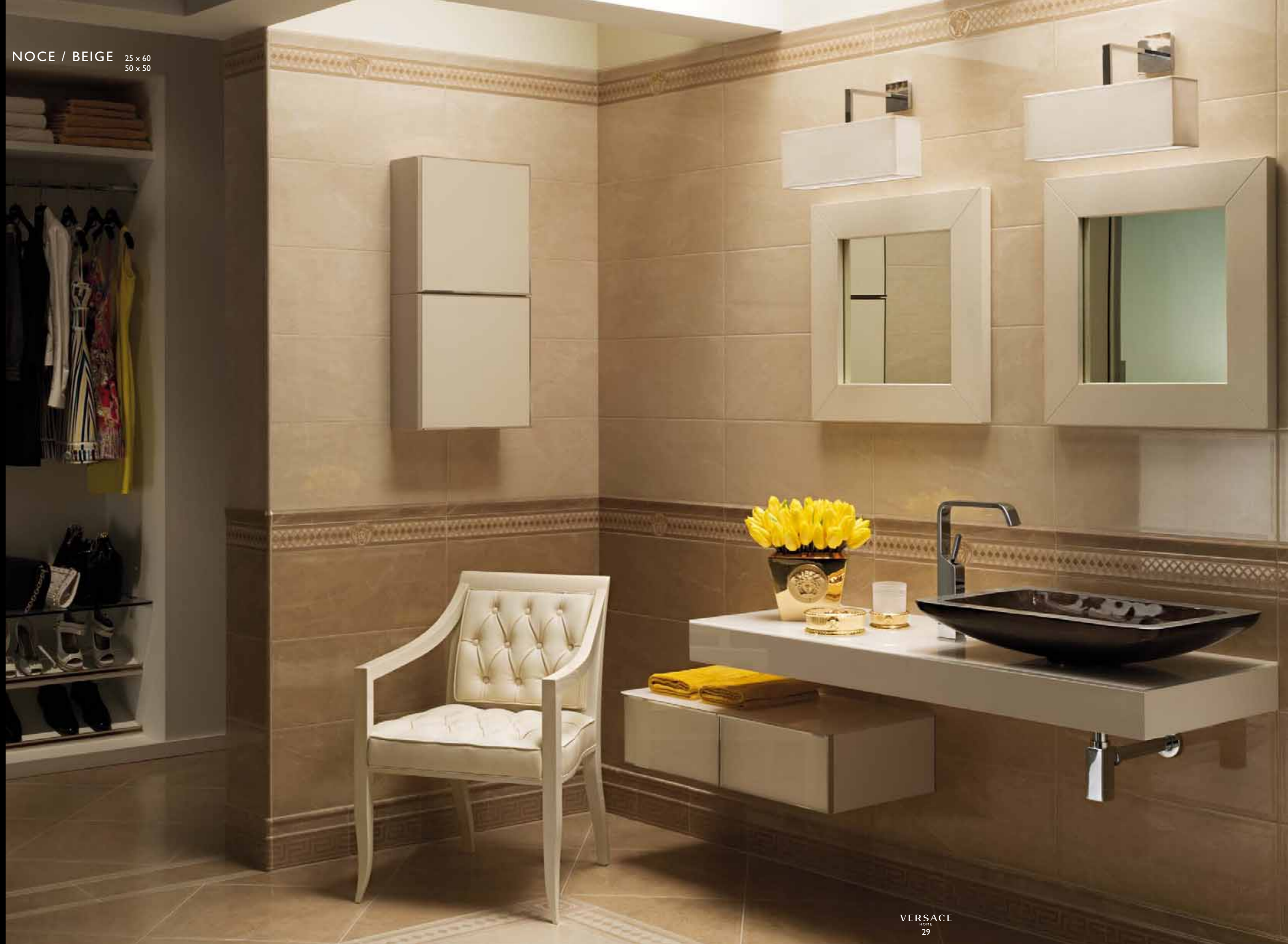

VENERE

NOCE / BEIGE 25 x 60
50 x 50

RIV: FASCIA GEOMETRICA 7,8x60

TORELLO 4x60

BATTISCOPA 15x25

PAV: FASCIA GEOMETRICA 15,3x50

FASCIA GRECA 4x50

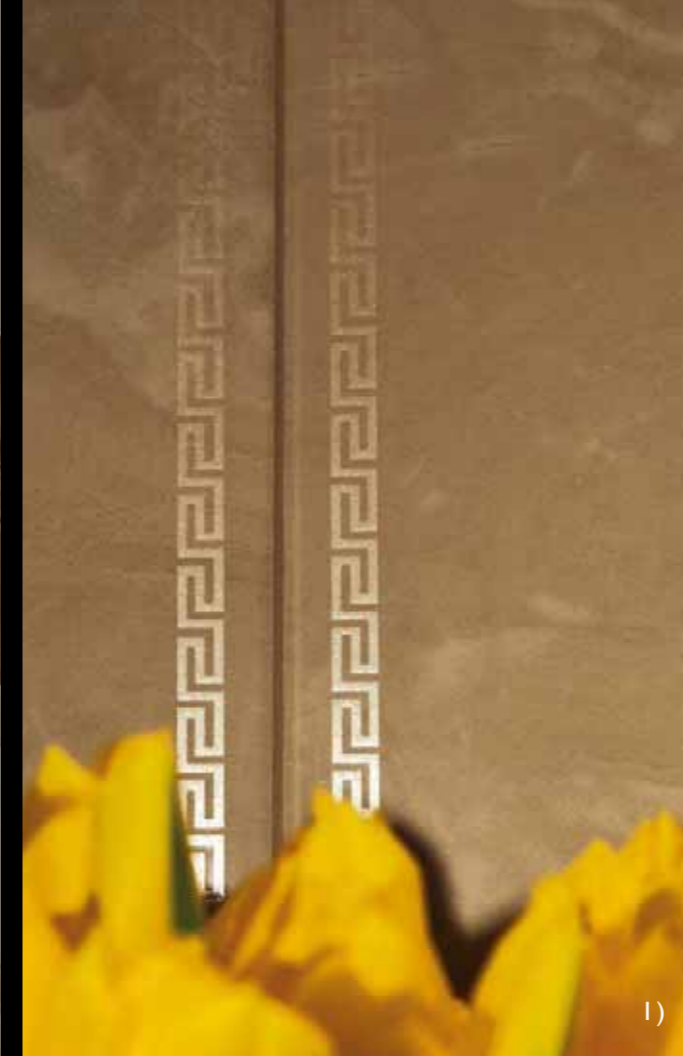

1)



2)

1) NOCE 25x60

2) FASCIA GEOMETRICA 7,8x60

3) NOCE 50x50
FASCIA GEOMETRICA 15,3x50



3)

VENERE
NOCE / ALMOND 50 x 50



VENERE
NOCE / ALMOND 50 x 50
FASCIA GEOMETRICA 15,3x50
TOZZETTO GEOMETRICO 15,3x15,3



VENERE

NOCE / ALMOND 50 x 50
RIV: MOSAICO E COLONNA PALACE LIVING GOLD



VENERE
NOCE 50 x 50
FASCIA GEOMETRICA 15,3x50
TOZZETTO GEOMETRICO 15,3x15,3



- 1) NOCE / ALMOND 50x50
FASCIA GEOMETRICA 15,3x50
- 2) NOCE 50x50
FASCIA GEOMETRICA 15,3x50
- 3) NOCE 50x50
FASCIA GEOMETRICA 15,3x50





VENERE

GRIGIO / BIANCO

VENERE

GRIGIO / BIANCO
25 x 60
50 x 50



VENERE
GRIGIO / BIANCO

25 x 60
50 x 50

MOSAICO 25x60
BATTISCOPA 15x25

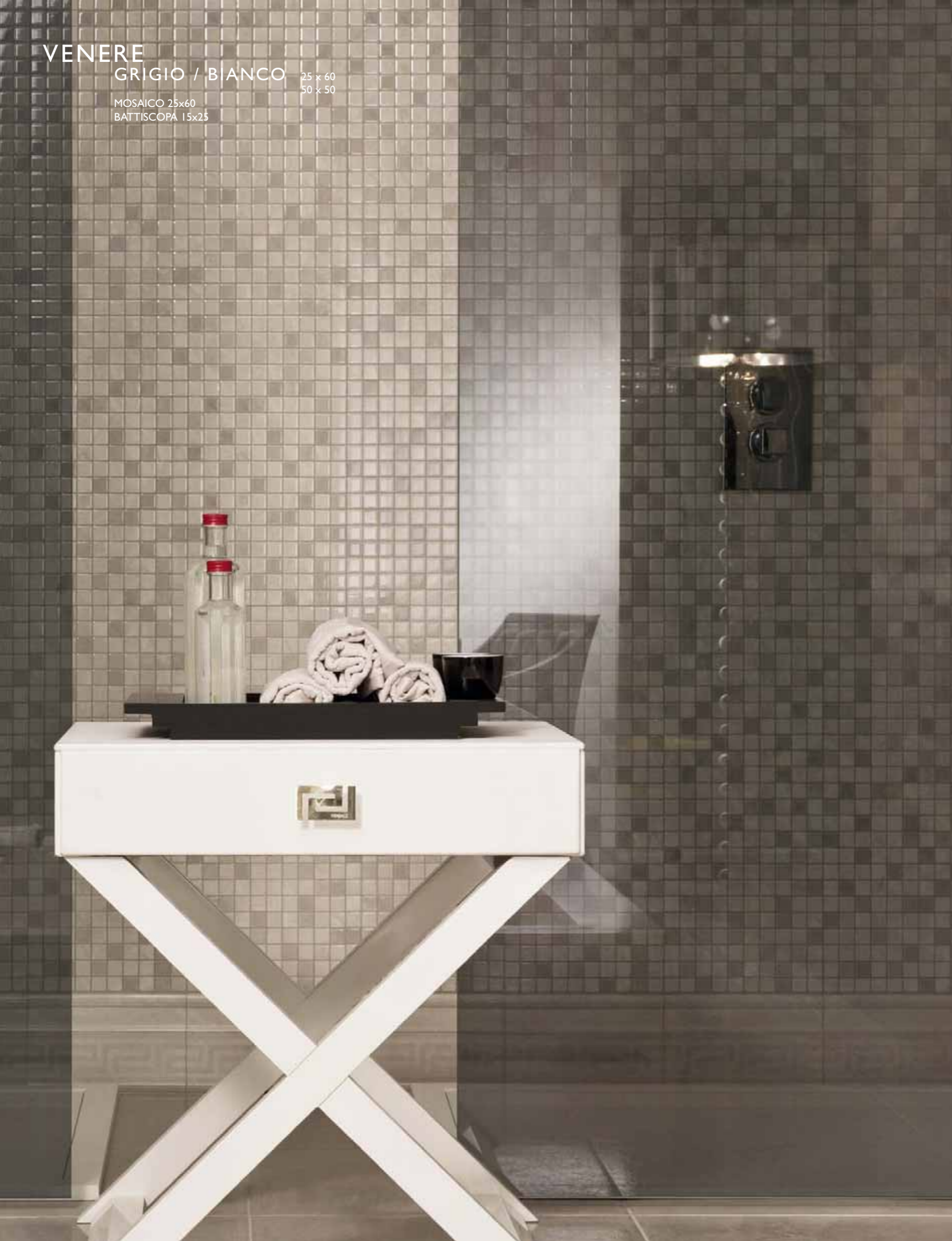

1)



2)

- 1) GRIGIO / BIANCO 25x60
FASCIA FOGLIA 7,8x25
TORELLO GRIGIO 4x25
- 2) BIANCO / GRIGIO 50x50
FASCIA FOGLIA 15,3x50
TOZZETTO FOGLIA 15,3x15,3

VENERE

GRIGIO / BIANCO 25 x 60
50 x 50



VENERE
GRIGIO / BIANCO 50 x 50
FASCIA FOGLIA 15,3x50



- 1) GRIGIO / BIANCO 50x50
BATTISCOPIA 15x25
- 2) GRIGIO / BIANCO 50x50
FASCIA FOGLIA 15,3x50
- 3) BOISERIE GRIGIA 25x60
- 4) BATTISCOPIA GRIGIO 15x25





VENERE

BIANCO

GRIGIO / BIANCO 25 x 60
50 x 50





1)



2)



VENERE
BIANCO / GRIGIO 25 x 60
 50 x 50

RIV: MOSAICO 25x60
 BOISERIE 25x60
 BATTISCOPA 15x25

PAV: FASCIA GEOMETRICA 15,3x50
 TOZZETTO GEOMETRICO 15,3x15,3
 FASCIA GRECA 4x50

1) GRIGIO / BIANCO 25x60
 COLONNA BIANCA 19,7x39,4
 FASCIA GEOMETRICA 7,8x25
 TORELLO BIANCO 4x25

2) BOISERIE BIANCA 25x60
 FASCIA GEOMETRICA 7,8x25
 TORELLO BIANCO 4x25

3) GRIGIO / BIANCO 50x50
 FASCIA GRECA 4x50

4) MOSAICO BIANCO / GRIGIO 25x60
 LISTELLO GRECA 3x60

VENERE



3)



4)

VERSACE HOME

VENERE

COMPOSIZIONE DEL LUSO

Luxury composition - Composition du luxe - Die Luxus Komposition

La composición del lujo - Состав роскоши - 奢华的构成



CLASSIC SIZE AND REFINED DECOR

Venere is the collection designed to make the home beautiful beyond time and beyond fashion. The 50x50 size with its embellishments adds a tone of subdued luxury to any space. Colours in harmony with nature and advanced processing technologies allow for the creation of exclusive pieces which are classic in size and innovative in their manufacturing processes. Thanks to Hi-Res Print technology each element is unique and unrepeatable. Subtle and refined embellishments adorn Venere: a 24-carat gold leaf illuminates the Versace Medusa, the decoration with the border follows the tile profile creating an infinite, elegant, precious pattern.

FORMAT CLASSIQUE ET DÉCORS RAFFINÉS

Venere est une collection spécialement conçue, afin de rendre l'habitation plus belle au-delà du temps et des modes. Le format 50x50 ainsi que ses décors donnent aux milieux le ton d'un luxe sans affectations. Des coloris en parfaite harmonie avec la nature joints à des technologies d'exécution à l'avant-garde permettent de créer des pièces exclusives, classiques dans le format et innovantes lors des processus de production. C'est grâce à la technologie Hi-Res Print que chaque élément est unique et rare. Des décors légers et raffinés enrichissent Venere : une feuille en or de 24 carats illumine la méduse Versace, la décoration avec la frise grecque épouse les profils des céramiques, en créant ainsi un motif infini, élégant et précieux.

KLASSISCHES FORMAT UND EDLE DEKORE

Die Kollektion Venere bietet die gestalterische Lösung für ein zeitlos schönes Zuhause. Das Format 50x50 und seine Dekore inszenieren ein Ambiente von dezenterem Luxus. Farben in Harmonie mit der Natur und hochmoderne Bearbeitungstechniken bilden die Grundlage für einzigartige Artikel in klassischem Format und mit innovativer Technik. Das Hi-Res-Print-Verfahren macht jedes einzelne Element einzigartig und unnachahmlich. Zarte, erlesene Dekore machen Venere noch kostbarer. Ein 24-karätiges Goldblatt lässt die Versace Medusa aufleuchten, und ein Mäandermotiv folgt den Fliesenprofilen in einer edel-elegant fließenden Linie.

FORMATO CLÁSICO Y DECORACIONES REFINADAS

Venere es la colección diseñada para darle una belleza atemporal a la casa, más allá de las modas. El formato 50x50 y sus decoraciones otorgan a los distintos ambientes el tono de un lujo refinado. Colores en armonía con la naturaleza y tecnologías de fabricación a la vanguardia que permiten crear piezas exclusivas, clásicas en cuanto al formato e innovadoras en los procesos de producción. Gracias a la tecnología Hi-Res Print cada uno de los elementos es único e irreplicable. Unas decoraciones suaves y refinadas embellecen Venere: una lámina de oro de 24 kilates ilumina la medusa Versace, la decoración con la cenefa sigue el perfil de la cerámica creando un dibujo infinito, elegante y precioso.

КЛАССИЧЕСКИЙ ФОРМАТ И ИЗЫСКАННЫЕ ДЕКОРЫ

Коллекция Venere была создана для придания дому красоты, не подвластной времени и веяниям моды. Формат 50x50 и его декоры придают помещению тон изысканной роскоши. Гармонирующие с природой цвета, передовые технологии обработки позволяют создавать эксклюзивные изделия, классические по формату и инновационные по производственным процессам. Благодаря технологии Hi-Res Print каждый отдельный элемент приобретает уникальность и неповторимость. Легкий изысканный декор еще больше повышает ценность коллекции Venere: фольга из золота 24 карата освещает медузу Versace, декор с меандром повторяет профиль керамики, создавая бесконечный, элегантный, ценный мотив.

经典造型，精致图纹

Venere的设计，力求令家居装饰拥有永不过时之美。50x50的规格及其图纹，为家居环境增添稳重奢华之感。颜色与自然和谐一致，而先进工艺带来与众不同的作品，造型经典，生产工序先进。高端的Hi-Res Print印花技术，令每一个细节都独特而不可复制。精致的花纹令Venere更显珍贵：24k金叶照亮范思哲的美杜莎头像，陶瓷轮廓上的希腊回纹装饰，创造出永恒、优雅、高贵的格调。

FORMATO CLASSICO E RAFFINATI DECORI

Venere è la collezione progettata per rendere la casa bella oltre il tempo e al di là delle mode. Il formato 50x50 e i suoi decori donano agli ambienti il tono di un lusso pacato. Colori in armonia con la natura, tecnologie di lavorazione all'avanguardia permettono di creare pezzi esclusivi, classici nel formato ed innovativi nei processi produttivi. Grazie alla tecnologia Hi-Res Print ogni singolo elemento è unico e irripetibile. Decorì lievi e raffinati impreziosiscono Venere: una foglia d'oro da 24 carati illumina la medusa Versace, la decorazione con la greca segue i profili delle ceramiche creando un motivo infinito, elegante e pregiato.





SUPERFICIE DAMASCATA

Dalla spinta verso le innovazioni tecnologiche di Gardenia Orchidea applicata al formato della più classica tradizione ceramica, nasce Venere.

Sottili venature tridimensionali che attraversano i pavimenti, ottenute con lavorazioni all'avanguardia, fanno di Venere un prodotto indispensabile in una casa dove regna il piacere di vivere.



DAMASCENE SURFACES

The technological innovations applied by Gardenia Orchidea to the format of the utmost in classical tradition give rise to Venere. Subtle three-dimensional veins that cross the floor, obtained through avant-garde production techniques, make Venere an indispensable product in a home where the joy of living is all that matters.

SURFACES DAMASSÉES

Venere est le fruit de l'élan de Gardenia Orchidea vers les innovations technologiques appliqué au format le plus classique de la tradition céramique. Obtenues grâce à des procédés de fabrication d'avant-garde, de fines veines tridimensionnelles parcourent les revêtements de sol céramiques: elles font de Venere un produit indispensable à une habitation où règne le plaisir de vivre.

DAMASZIERTE OBERFLÄCHE

Die Innovationsfreude von Gardenia Orchidea gepaart mit dem klassischen Keramikformat. Zarte tiefgründige Äderungen, die in hochmodernen Verfahren hergestellt werden, durchziehen die Bodenfläche. Mit dieser Optik erweist sich Venere als ideale Gestaltungslösung für souveräne Wohnlichkeit.



SUPERFICIE DAMASCADA

Venere nasce gracias al impulso hacia la innovación tecnológica de Gardenia Orchidea aplicada al formato de la tradición cerámica más clásica. Las finas vetas tridimensionales que atraviesan los pavimentos, trazadas con elaboraciones de vanguardia, hacen de Venere un producto indispensable para una casa en la que reine el placer de vivir.

«ДАМАСКИРОВАННАЯ» ПОВЕРХНОСТЬ

ВЛЕЧЕНИЕМ КОМПАНИИ GARDENIA ORCHIDEA К ТЕХНОЛОГИЧЕСКИМ НОВОВВЕДЕНИЯМ В СОЧЕТАНИИ С ФОРМАТОМ КЛАССИЧЕСКОЙ КЕРАМИЧЕСКОЙ ТРАДИЦИИ БЫЛА РОЖДЕНА КОЛЛЕКЦИЯ VENERE. ТОНКИЕ РЕЛЬЕФНЫЕ ПРОЖИЛКИ, ТЯНУЩИЕСЯ ПО ВСЕМУ ПОЛУ, СОЗДАННЫЕ БЛАГОДАРЯ ПЕРЕДОВОЙ ТЕХНОЛОГИИ ОБРАБОТКИ, ПРИДАЮТ ПРОДУКЦИИ VENERE ХАРАКТЕР НЕЗАМЕНИМОСТИ ДЛЯ ДОМА, В КОТОРОМ НАСЛАЖДЕНИЕ ЖИЗНЬЮ ПРЕВЫШЕ ВСЕГО.

花纹表面

Gardenia Orchidea在最经典传统的瓷砖规格上推进采用革新技术,从而诞生了Venere。通过前卫的加工在地砖表面形成贯穿的三维精细纹理,使Venere成为享受生活的家居中必不可少的一种产品。



POLISHED DECORATIONS

Each element is accurately polished to attain extraordinary brilliance.

DÉCORS POLIS

Chaque élément est soumis à un rigoureux processus de polissage, ce qui lui confère une brillance exceptionnelle.

POLIERTE DEKORATIONEN

Jedes einzelne Element wird einem schonenden Polierverfahren unterzogen, das für außergewöhnliche Glanzeffekte sorgt.

DECORACIONES PULIDAS

Cada uno de los elementos es sometido a un escrupuloso proceso de abricantado que le confiere una luminosidad excepcional.

ПОЛИРОВАННЫЙ ДЕКОР

Каждый элемент подвергается тщательному полировальному процессу, который позволяет достичь исключительного блеска.

光滑的表面

每块地砖均经过细致的抛光工艺处理,从而获得异常闪亮的效果。



DECORAZIONI LEVIGATE

Ogni singolo elemento viene sottoposto ad uno scrupoloso processo di lucidatura che consente di ottenere una eccezionale brillantezza.





ARMONIA DELLA COMPOSIZIONE

Composizioni speciali per creare un palcoscenico eclettico dove vivere il quotidiano. L'abbinabilità dei colori e le grafiche raffinate consentono di rendere unica ogni realizzazione.

HARMONY IN COMPOSITION

Special compositions create an eclectic setting for daily living. The infinite number of combinations of colours and refined designs makes each home truly unique.

HARMONIE DE LA COMPOSITION

Des compositions spéciales pour créer une scène éclectique où vivre le quotidien. Des couleurs qui se marient entre elles, un graphisme raffiné: chaque réalisation devient ainsi unique.

HARMONIE DER KOMPOSITIONEN

Raffiniert abgestimmte Kompositionen schaffen ein eklektisches Wohnambiente. Vielfältig kombinierbare Farben und erlesene Dessins lassen einzigartige Gestaltungskonzepte entstehen.

ARMONÍA DE LA COMPOSICIÓN

Composiciones especiales para crear un escenario ecléctico en el que vivir lo cotidiano. La posibilidad de combinar colores y gráficas refinadas convierten en única cada realización.

ГАРМОНИЯ КОМПОЗИЦИИ

Специальные композиции для создания эклектической сцены для ежедневного быта. Сочетаемость цветов и изысканной графики наделяет уникальностью любое исполнение.

构成的和谐

特殊的构成让日常生活环境成为一个丰富多样的舞台。考究的色彩与图案的结合让每一个设计都无与伦比。



IN THE NAME OF PERFECTION

The skill of the Gardenia Orchidea craftsmen has exceeded the highest levels of precision: the border, the unmistakable symbol of Versace Home décor, flows seamlessly along the walls even creating a perfect design on the trim.

SOUS LE SIGNE DE LA PERFECTION

L'habileté des artisans expérimentés Gardenia Orchidea a dépassé les niveaux de précision maximums: la frise grecque, le symbole du décor Versace Home tout à fait unique, coule sans solution de continuité le long des parois, en créant un dessin parfait même sur l'angle.

IM ZEICHEN DER VOLLKOMMENHEIT

Die Handfertigkeit der Meisterdekorateure von Gardenia Orchidea übertrifft selbst höchste Ansprüche: das Mäandermotiv, unverwechselbares Symbol von Versace Home, verläuft unterbrechungslos die Wände entlang und erzeugt ein auch an den Ecken perfektes Muster.

A LA BÚSQUEDA DE LA PERFECCIÓN

La maestría de los expertos artesanos de Gardenia Orchidea ha superado los niveles máximos de precisión: la cenefa, símbolo del inconfundible décor Versace Home, discurre en continuidad a lo largo de las paredes, creando un dibujo perfecto incluso en las esquinas.

ПОД ЗНАКОМ СОВЕРШЕНСТВА

Мастерство ремесленников Gardenia Orchidea превзошло максимальные уровни точности меандр, символ неповторимого декора Versace Home, непрерывно струится по стенам, создавая безукоризненный рисунок даже на углах.

完美主义的标志

Gardenia Orchidea公司的工艺专家技艺炉火纯青; 范思哲家居的独特装饰希腊回纹装饰, 沿着墙面无缝连接, 包括边缘处亦线条完美。

DETTAGLI DI LUCE

Venere esplora nuove potenzialità espressive della materia ceramica, gioca con la luce e disegna atmosfere ricercate. Sorprendono le applicazioni di smalto traslucido che passano dal tono su tono alla massima lucentezza, un contrasto cromatico dall'eleganza inequivocabile.



NEL SEGNO DELLA PERFEZIONE

La maestria degli esperti artigiani Gardenia Orchidea ha superato i massimi livelli di precisione: la greca, simbolo dell'inconfondibile décor Versace Home, scorre senza soluzione di continuità lungo le pareti, creando un disegno perfetto anche sullo spigolo.

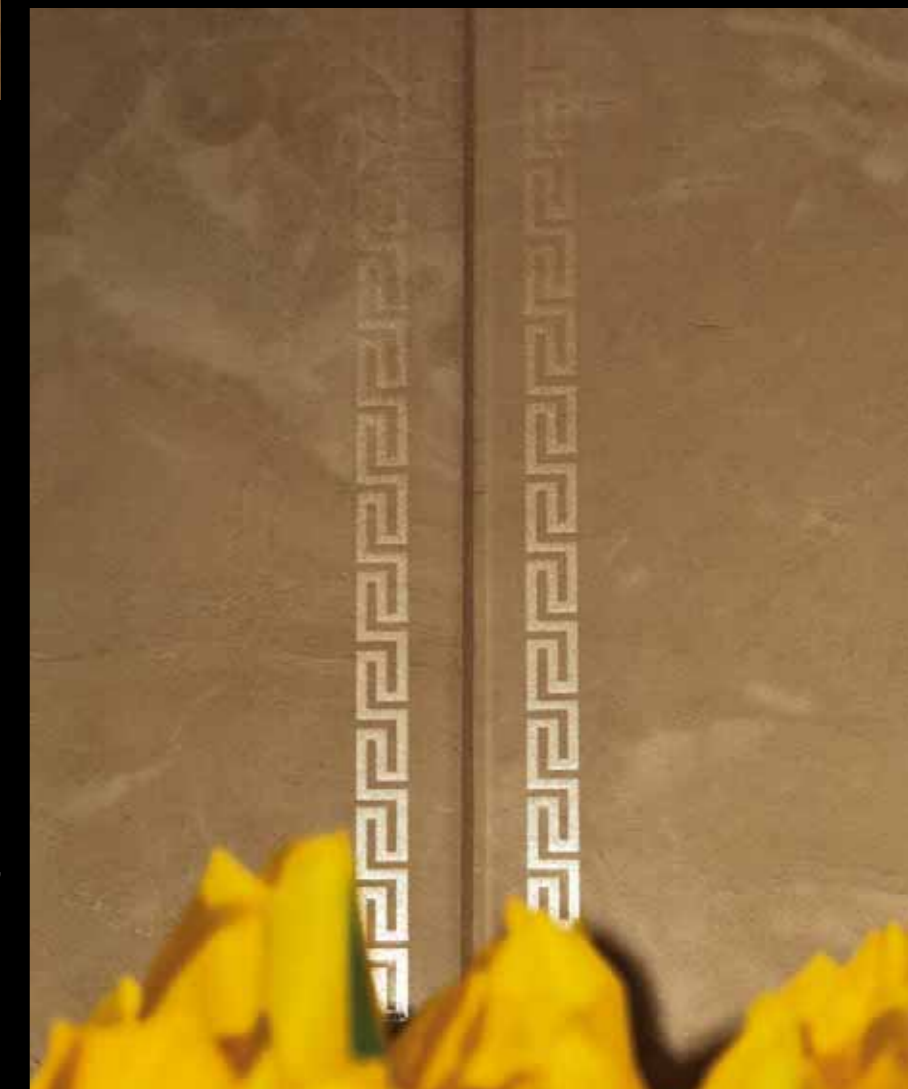

DETAILS OF LIGHT

Venere explores a new expressive potential of tiles, playing with light and designing the sought after atmosphere. Surprising applications of translucent enamel which pass from one tone to another reaching maximum brightness, contrasting colours with unmistakable elegance.

DÉTAILS DE LUMIÈRE

Venere explore de nouvelles potentialités d'expression de la matière céramique, joue avec la lumière et dessine des atmosphères raffinées. Les applications d'émail translucide, passant du ton sur ton à la brillance maximum, un contraste chromatique d'une élégance sans équivoque, surprennent agréablement.

DETAILS AUS LICHT

Venere erkundet ein neues Ausdruckspotenzial der Keramik, spielt mit dem Licht und lässt erlesene Atmosphären entstehen. Überraschende Applikationen durchscheinender Glasuren, von Ton in Ton bis zu maximalem Glanz: Kontrasteffekte von einer Eleganz ohnegleichen.

DETALLES DE LUZ

Venere explora nuevas posibilidades expresivas del material cerámico, juega con la luz y diseña atmósferas refinadas. Sorprenden las aplicaciones de esmalte translúcido que pasan del tono sobre tono al máximo brillo, un contraste cromático de elegancia inconfundible.

ДЕТАЛИ СВЕТА

Коллекция Venere раскрывает новые экспрессивные возможности керамического материала, играет со светом, создавая изысканную атмосферу. Поражает использование прозрачной глазури, тона которой постепенно переходят к максимальному блеску, создавая цветовой контраст невероятной элегантности.

光线细节

开拓陶瓷新表达, Venere善于把玩光线, 营造气氛。渐变的半透明珐琅质令人惊艳, 色调对比优雅至极。

FASCINO DISCRETO

L'accurata ricerca stilistica e la raffinata lavorazione artigianale caratterizzano la collezione Venere. Alto valore estetico anche per il coprispigo che diventa pregiato dettaglio di stile sia per il rivestimento che per il pavimento.

DISCREET CHARM

Careful stylistic research and fine craftsmanship are the hallmark of the Venus collection. High aesthetic value even for the trim cover which becomes a precious detail both for the walls and the flooring.

SÉDUCTION DISCRÈTE

La recherche de style soignée et l'exécution artisanale raffinée sont la caractéristique principale de la collection Venere. Une valeur esthétique élevée même pour le cache-angle, devenant ainsi un détail de style précieux aussi bien pour le revêtement que pour le sol.

DEZENTE FASZINATION

Das hohe Stilbewusstsein und die gelungene Bearbeitung von Meisterhand sind das besondere Kennzeichen der Kollektion Venere. Von hohem ästhetischem Wert ist auch der Kantenschutz, der sowohl an den Wand- als auch an den Bodenfliesen zu einem edlen Stildetail wird.

FASCINACIÓN DISCRETA

La cuidadosa búsqueda de estilo y la refinada elaboración artesanal son el trazo distintivo de la colección Venere. Alto valor estético también para la cantonera, que se convierte en un preciado detalle de estilo tanto para el revestimiento como para el pavimento.

СДЕРЖАННОЕ ОЧАРОВАНИЕ

Тщательный поиск стиля и изысканная ремесленная обработка являются отличительной чертой коллекции VENERE. Высокая эстетическая ценность заключена и в уголке, который превращается в ценную деталь стиля как для облицовки стен, так и для покрытия пола.

高品质魅力

精雕细琢的风格，品质精致的工艺，是Venere系列的独特之处。包括边角装饰瓷砖也具备高质量的审美价值，可用于墙面和地板的装饰，都细节完美，别具风格。



GEOMETRIE RILUCENTI

Le boiserie di Venere propongono decorazioni semplici e al tempo stesso esclusive, che possono essere utilizzate ovunque si desideri arricchire la qualità dell'architettura d'interni: dalla casa da ristrutturare a quella di nuova costruzione. Creazioni artigianali su misura che trasformano gli spazi in ambienti unici e personali. Grazie al sapiente impiego di smalti iridescenti, le superfici diventano ancora più brillanti, vibranti di luce, illuminano gli spazi creando atmosfere sofisticate.



SPARKLING GEOMETRY

Venus wood panelling offers a simple decor which is at the same time exclusive and which can be used anywhere you want to enhance the quality of interior design: from the house which is to be renovated to that of a new build. Custom handmade creations that transform spaces into unique and personal surroundings. Thanks to the wise use of iridescent enamels, the surfaces are even more brilliant, vibrant with light, illuminating the spaces creating sophisticated atmospheres.

GEOMÉTRIES RELUISANTES

Les boiseries de Venere proposent des décorations simples et à la fois exclusives, pouvant être utilisées en tout lieu, où l'on souhaiterait enrichir la qualité de l'architecture d'intérieurs : de la maison à restructurer à celle de nouvelle construction. Des créations artisanales sur mesure transformant les espaces dans des milieux uniques et personnels. C'est grâce à l'emploi adroit d'émaux iridescents que les surfaces deviennent encore plus brillantes, vibrantes de lumière, qu'elles éclairent les espaces, en créant des atmosphères tout à fait sophistiquées.

GEOMETRIEN IN EDELEM SCHIMMER

Die Boiserie-Dekore von Venere sind schlicht und exklusiv zugleich. Sie können überall dort eingesetzt werden, wo die Qualität der Innenarchitektur aufgewertet werden soll: von der Altbauseanierung bis zum Neubau. Handwerkliche Kreationen nach Maß verwandeln den Raum in ein einzigartiges Ambiente mit ganz persönlichem Flair. Dank der meisterhaften Verwendung irisierender Glasuren erhalten die Flächen noch mehr Leuchtkraft; ihr vibrierendes Licht erhellt den Raum und erzeugt eine immer wieder bestechende Atmosphäre.

GEOMETRÍAS RELUCIENTES

Las boiserías de Venere proponen decoraciones simples y al mismo tiempo exclusivas, que pueden utilizarse allí donde se desee enriquecer las cualidades de la arquitectura de interiores: desde la casa para reformar hasta la de obra nueva. Creaciones artesanales a medida que transforman los espacios en ambientes únicos y personales. Gracias al sabio uso de esmaltes iridescentes, las superficies se hacen aún más brillantes, impregnadas de luz, que iluminan los espacios creando atmósferas sofisticadas.

СИЯЮЩИЕ ГЕОМЕТРИЧЕСКИЕ ФОРМЫ

Панели VENERE — это простое и одновременно эксклюзивные декоры, которые могут использоваться везде, где вы желаете обогатить отделку интерьера: и при ремонте старого дома, и при отделке нового. Созданные мастерами-ремесленниками на заказ, они преобладают помещению, придавая им уникальность и индивидуальность. Благодаря умелому использованию радужной эмали, поверхности приобретают еще бо́льший блеск, освещая пространства и создавая изысканную атмосферу.

閃亮的造型

无论是新建房屋还是家居装修，简约独特的Venere护墙板装饰，都适合用于为家居内部提升品质。手工定制，赋予家居环境独特个性。虹彩釉瓷的巧妙利用，令瓷砖表面更加流光溢彩，明艳照人，营造精致气氛。

MOSAICO EFFETTO SATIN

In Venere, innovazione estetica e funzionale si fondono per dare vita a spazi multisensoriali che permettono di sperimentare nuove progettualità attraverso una straordinaria tipologia di mosaico dalla superficie morbida, perfettamente liscia, resa ancor più luminosa dall'applicazione di una maggiore quantità di smalto, che aumenta lo spessore e dona alle singole tessere un'elevata capacità di riflessione.



SATIN EFFECT MOSAIC

In Venus, aesthetic and functional innovations combine to create spaces that allow multi-sensory experience of new projects through a special type of mosaic with a soft, smooth surface which is made even more luminous by a greater quantity of enamel increasing the thickness and making the individual tiles highly reflective.

MOSAÏQUE EFFET SATIN

Dans Venere, innovation esthétique et fonctionnelle se fondent pour créer des espaces multisensoriels permettant d'expérimenter de nouvelles conceptions à travers une typologie extraordinaire de mosaïque à la surface souple, parfaitement lisse, rendue encore plus lumineuse par l'application d'une plus grande quantité d'émail, qui augmente l'épaisseur et donne à chaque carreau de mosaïque une capacité de réflexion élevée.

MOSAİK MIT SATIN-EFFEKT

Venere vereint ästhetische und funktionale Innovation zu einer räumlichen Erfahrung, die alle Sinne einbezieht. Durch einen unvergleichlichen Mosaiktyp lassen sich neue Projektideen verwirklichen: die weich wirkende, vollkommen glatte Oberfläche erhält durch den Auftrag einer größeren Glasurmenge noch mehr Glanz und Stärke; zudem verleiht dies den Mosaikfliesen ein hohes Reflexionsvermögen.

MOSAICO EFECTO SATIN

En Venere, la innovación estética y funcional se unen para dar vida a espacios multisensoriales que permiten experimentar nuevos diseños a través de una extraordinaria tipología de mosaico de superficie suave, perfectamente lisa y aún más luminosa gracias a la aplicación de una mayor cantidad de esmalte, que aumenta el grosor y proporciona a cada uno de los mosaicos una elevada luminosidad.

МОЗАИКА С САТИНИРОВАННЫМ ЭФФЕКТОМ

В коллекции Venere эстетическое и функциональное новаторство сливаются, создавая пространства, воздействующие на все органы чувств. Это позволяет экспериментировать с новыми проектами, применяя необычную мозаику с мягкой, абсолютно гладкой поверхностью, еще более блестящей благодаря применению большего количества эмали, которая увеличивает толщину и придает отдельным кусочкам повышенную отражательную способность.

丝质效果马赛克

为了创造多感官空间，Venere充分发挥审美和功能创意，实验新的设计，研制出表面柔顺的特殊马赛克，为优质抛瓷增添明亮、厚度和反光度。





SOLUZIONI COMPOSITE PERSONALIZZATE

Nessun limite alla creatività e all'immaginazione progettuale: il modulo colonna, opportunamente tagliato, può diventare motivo decorativo dell'architrave che accompagna il passaggio tra la zona living e la sala da bagno. Torello e listello invece possono essere utilizzati nella creazione di un'elegante cornice che delimita lo spazio dedicato allo specchio. Queste sono solo alcune delle infinite soluzioni composite che si possono realizzare con Venere per arredare gli spazi secondo il tratto distintivo di chi li abita.



CUSTOMIZED SOLUTIONS

There are no limits to the creativity and imagination of design: the column module, properly cut, may become a decorative lintel that accompanies the transition between the living area and the bathroom. Torellos and listels can be used instead to create an elegant frame that delimits the space for the mirror. These are just some of the infinite number of compositions that can be made with Venus to furnish a space following the distinctive features of those who will live in.

SOLUTIONS DE COMPOSITION PERSONNALISÉES

Aucune limite n'est posée à la créativité et à l'imagination de conception : le module colonne, opportunément découpé, peut devenir un motif de décoration du linteau qui accompagne le passage entre la zone living et la salle de bains. Par contre la bordure et le listel peuvent être utilisés dans la création d'un cadre élégant délimitant l'espace dédié au miroir. Ce ne sont là que quelques-unes des solutions de composition infinies pouvant être réalisées avec Venere pour décorer les espaces suivant la caractéristique personnelle de leurs habitants.

KUNDENSPEZIFISCHE KOMPOSITIONEN

Der gestalterischen Freiheit und Kreativität sind keine Grenzen gesetzt: das Säulenmodul kann bei entsprechendem Schnitt zu einem Dekorelement für den Architrav werden, der den Übergang zwischen Wohnraum und Bad begleitet. Wulst und Leiste lassen sich hingegen zur Kreierung eleganter Spiegeleinfassungen verwenden. Und das sind nur einige der unendlichen Kompositionsmöglichkeiten, mit denen Venere den Raum ganz nach dem Geschmack seiner Bewohner zu gestalten vermag.

SOLUCIONES Y COMBINACIONES PERSONALIZADAS

Ningún límite para la creatividad y la imaginación en los proyectos: el módulo columna, adecuadamente cortado puede convertirse en el motivo decorativo del dintel del architrave que acompaña el paso entre el salón y el cuarto de baño. En cambio, pueden utilizarse bordes redondeados y listeles para crear un elegante marco que delimite el espacio dedicado al espejo. Éstas son sólo algunas de las soluciones compositivas que se pueden realizar con Venere para decorar los espacios en función del estilo distintivo de quien los habita.

ПЕРСОНАЛИЗИРОВАННЫЕ КОМПОЗИЦИОННЫЕ РЕШЕНИЯ

Никаких ограничений для творчества и фантазии при разработке проекта: модуль колонны при соответствующей подрезке может стать элементом перемычки на переходе из зала в ванную. Валик и планка могут использоваться для создания элегантной рамы, обрамляющей пространство, отведенное под зеркало. Это только некоторые из бесконечного множества композиционных решений, возможных благодаря коллекции Venere, для отделки помещений с приданием им индивидуальности тех, кто в них живет.

个性化设计

设计创意想象力无限：切割适宜的门楣，巧妙实现从居室到浴室的过渡；不规则形边饰砖和腰线砖，则可用于设计优雅的镜框。这些仅是Venere个性化家居装饰无限创意中的个别例子。



VERSACE HOME

VENERE

IN DETTAGLIO

In detail - En détail - Im Detail
En detalle - Детально - 细节

Pavimenti 50x50 • 13 - 1,000 m²/box - ± 10,00 mm



ISO 3

17220 ALMOND



ISO 3

17221 BEIGE



ISO 3

17222 ORO



ISO 3

17223 NOCE



ISO 3

17224 GRIGIO



ISO 3

17219 BIANCO

Firma 4,8x9,6 • 14 - 4 pcs/box



118008 GOLD



118009 PLATINO

Fascia greca gold 4x50 • 25 - 8 pcs/box

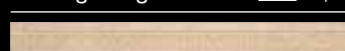

17260 ALMOND/BEIGE



17261 ORO

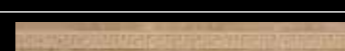

17262 NOCE



17264 GRIGIO



17263 BIANCO

Tozzetto medusa gold 4x4 • 08 - 4 pcs/box



17270 ALMOND/BEIGE



17271 ORO



17272 NOCE



17274 GRIGIO



17273 BIANCO



Tozzetto greca 4x4 • 08 - 4 pcs/box



17275 ALMOND/BEIGE



17276 ORO



17277 NOCE



17279 GRIGIO



17278 BIANCO



Fascia geometrica 15,3x50 • 52 - 8 pcs/box (mix 2 soggetti)



17240 ALMOND/BEIGE



17241 ORO



17242 NOCE



17244 GRIGIO



17243 BIANCO

Tozzetto fascia geometrica 15,3x15,3 • 25 - 4 pcs/box



17245 ALMOND/BEIGE

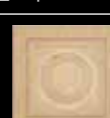

17246 ORO

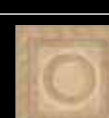

17247 NOCE



17249 GRIGIO



17248 BIANCO

Fascia foglia 15,3x50 • 52 - 8 pcs/box



17250 ALMOND/BEIGE



17251 ORO



17252 NOCE

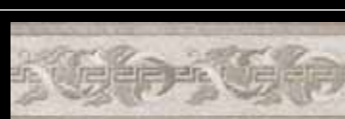

17254 GRIGIO



17253 BIANCO

Fascia foglia medusa 15,3x50 • 58 - 8 pcs/box



17265 ALMOND/BEIGE



17266 ORO



17267 NOCE



17269 GRIGIO



17268 BIANCO

Tozzetto fascia foglia 15,3x15,3 • 25 - 4 pcs/box



17255 ALMOND/BEIGE



17256 ORO



17257 NOCE



17259 GRIGIO



17258 BIANCO

Rosone 100x100 • 77 - 1 pcs/box



17285 ALMOND/BEIGE



17286 ORO/NOCE



17287 BIANCO



17288 GRIGIO

Pezzi speciali

BATTISCOPIA 8x33 ● 07 - 30 pcs/box	BATTISCOPIA SCALA 8x66 ● 22 - 3 pcs/box	TORELLO GRADINO 5x33 ● 31 - 6 pcs/box
18170 ALMOND 18175 BEIGE 18180 ORO 18185 NOCE 18190 BIANCO 18195 GRIGIO	DX 18171 ALMOND 18176 BEIGE 18181 ORO 18186 NOCE 18191 BIANCO 18196 GRIGIO	SX 18172 18177 18182 18187 18192 18197
TORELLO ANGOLARE 5x66 ● 52 - 2 pcs/box	PROFILI OTTONE ● 37 - 6 pcs/box	PROFILI ACCIAIO LUCIDO ● 37 - 6 pcs/box
10695 ALMOND 10696 BEIGE 10697 ORO 10698 NOCE 10688 BIANCO 10689 GRIGIO	1117101 0,5x49 1117106 1x49	117104 0,5x49 117109 1x49

ASSEMBLAGGIO PEZZI SPECIALI

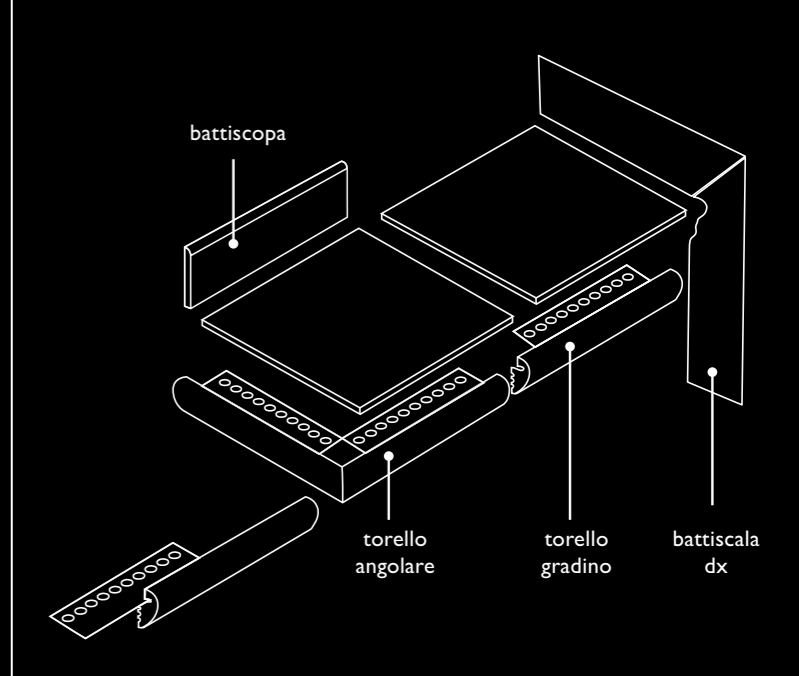

PAVIMENTO
Floor tile
Sol
Boden
Piso
Полы
地磚

SPESSORE MAGGIORATO
Increased thickness
Épaisseur majorée
Erhöhte Stärke
Espesor aumentado
Увеличенная толщина
加厚厚度

S SERIGRAFIA
Screen printing
Sérigraphie
Serigraphie
Serigrafia
Сериграфия
丝网印刷

METALLO PREZIOSO
Precious metals
Métaux précieux
Edelmetalle
Metales preciosos
ДРАГОЦЕННЫЙ МЕТАЛЛ
貴重金属

RESISTENTE AL GELO
Frost resistant
Résistant au gel
Frostbeständig
Resistencia al hielo
Морозоустойчивый
防冻

ISO CLASSE DI RESISTENZA ALL'ABRASIONE SUPERFICIALE (DOVE INDICATO)
Class of resistance to surface abrasion (where indicated)
Classe de résistance à l'abrasion superficielle (où mentionné)
Oberflächenabrieb-Beanspruchungsgruppe (wo bezeichnet)
Clase de resistencia a la abrasión superficial (cuando indicado)
Класс сопротивляемости поверхностному истиранию (где указано)
耐表面磨蚀等级 (标示之处)

3 TERZO FUOCO
Third firing
Troisième feu
Dritt-Brand
Cocción a tercer fuego
Третий обжиг
三次烧成

STAMPA AD ALTA RISOLUZIONE
High-definition printing
Impression haute résolution
Hochauflösungsdruck
Impresión de alta resolución
Печать с высоким разрешением
高分辨率印刷

RESISTENTE AGLI SBALZI TERMICI
Thermal shock resistant
Résistant aux écarts thermiques
Temperaturwechselbeständigkeit
Resistencia a las variaciones térmicas
Устойчивый к термоударам
耐热度波动

POSA CONSIGLIATA CON FUGA
Suggested laying with joint
Pose conseillée avec joint
Verlegung mit Fuge empfohlen
Colocación aconsejada con junta
Рекомендуется укладка со швом
建议的留缝隙施工

M METALLO
Metal
Métal
Metall
Metal
Металл
金属

TAGLIO A IDROGETTO
Water-jet cutting
Découpe à hydrojet
Wasserstrahlschnirr
Corte con hydro-jet
Водометная резка
水刀切割

ALTA RESISTENZA
High resistance
Haute résistance
Hohe Festigkeit
Alta resistencia
Высокая сопротивляемость
机械阻力高

PVD PHYSICAL VAPOUR DEPOSITION

L SUPERFICIE LUCIDA
Glossy surface
Surface brillante
Polierte Oberfläche
Superficie brillante
Глянцевая поверхность
闪亮表面

L LEVIGATO
Polished
Poli
Poliert
Pulido
Полированный
研磨

IMBALLI E PESI • PACKINGS AND WEIGHTS • EMBALLAGES ET POIDS • VERPACKUNGEN UND GEWICHTE • EMBALAJES Y PESOS • УПАКОВКИ И ВЕС • 包装和重量

EN 14411/G BIa GL

FORMATO SIZE	pz/mq pcs/sqm	pz/scat. pcs/box	mq/scat. sqm/box	kg/mq kg/sqm	kg/scat. kg/box	scat./pal box/pal	mq/pal sqm/pal	kg/pal
Pavimento 50x50	4	4	1,00	21,00	21,00	33	33,00	693,00
Firma 4,8x9,9	-	4	-	0,80	-	-	-	-
Fascia 4x50	-	8	4,00 ml	3,60	-	-	-	-
Tozzetto 4x4	-	4	-	0,14	-	-	-	-
Fascia 15,3x50	-	8	4,00 ml	13,20	-	-	-	-
Tozzetto 15,3x15,3	-	4	-	2,32	-	-	-	-
Rosone 100x100	-	1	-	21,00	-	-	-	-
Battiscopa 8x33,3	-	30	10,00 ml	10,55	-	-	-	-
Battiscopa scala 8x66	-	3	-	2,11	-	-	-	-
Torello gradino 5x33,3	-	6	2,00 ml	1,89	-	-	-	-
Torello angolare 5x66	-	2	-	1,20	-	-	-	-
Profilo metallo 0,5x49	-	6	2,94 ml	1,50	-	-	-	-
Profilo metallo 1x49	-	6	2,94 ml	0,90	-	-	-	-

Rivestimenti 25x60 • 17 - 1,200 m²/box



68000 BIANCO 68004 GRIGIO 68001 BEIGE 68002 ORO 68003 NOCE

Boiserie classica 25x60 • 23 - 4 pcs/box



68030 BIANCO 68034 GRIGIO 68031 BEIGE 68032 ORO 68033 NOCE

Battiscopa fascia rilievo 15x25 • 25 - 12 pcs/box

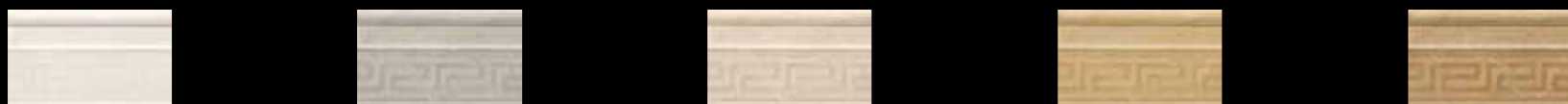

68100 BIANCO 68104 GRIGIO 68101 BEIGE 68102 ORO 68103 NOCE

Mosaici 25x60 • 36 - 1,200 m²/box

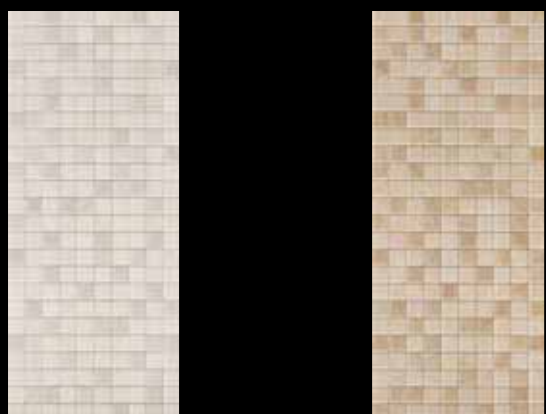

68015 BIANCO/GRIGIO 68016 BEIGE/ORO/NOCE

Firma 4,8x9,6 • 14 - 4 pcs/box



118008 GOLD

118009 PLATINO

Listello greca 3x60 • 23 - 5 pcs/box

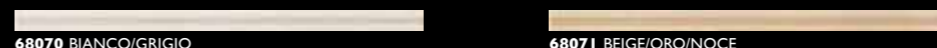

68070 BIANCO/GRIGIO 68071 BEIGE/ORO/NOCE

Fascia foglia 7,8x60 • 46 - 3 pcs/box



68060 BIANCO/GRIGIO 68061 BEIGE/ORO/NOCE

Fascia geometrica 7,8x60 • 46 - 3 pcs/box



68050 BIANCO/GRIGIO 68051 BEIGE/ORO/NOCE

Tozzetto 3x3 • 11 - 4 pcs/box

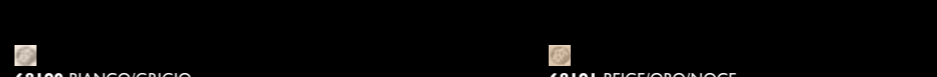

68190 BIANCO/GRIGIO 68191 BEIGE/ORO/NOCE

Colonna 19,7x39,4 • 55 - 4 pcs/box



68200 BIANCO 68201 BEIGE

Listello greca 3x25 • 16 - 12 pcs/box

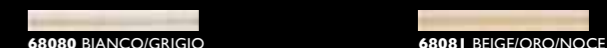

68080 BIANCO/GRIGIO 68081 BEIGE/ORO/NOCE

Fascia foglia 7,8x25 • 23 - 6 pcs/box

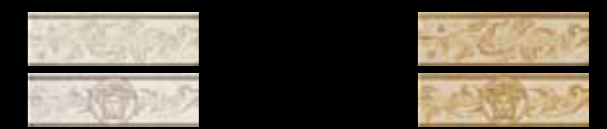

68065 BIANCO/GRIGIO 68066 BEIGE/ORO/NOCE

Fascia geometrica 7,8x25 • 23 - 6 pcs/box

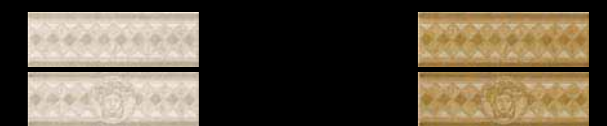

68055 BIANCO/GRIGIO 68056 BEIGE/ORO/NOCE

Girospecchio 7,8x7,8 • 19 - 4 pcs/box

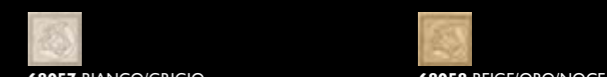

68057 BIANCO/GRIGIO 68058 BEIGE/ORO/NOCE

Terminale colonna 8x19,7 • 55 - 4 pcs/box

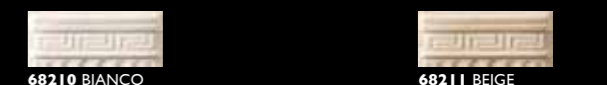

68210 BIANCO 68211 BEIGE

Composizione 50x60 • 75 - 1 pcs/box



68090 BIANCO/GRIGIO 68091 BEIGE/ORO/NOCE



Pezzi speciali S

S		S		S		S		S	
					ASSEMBLAGGIO PEZZI SPECIALI 				
● 11 - 36 pcs/box	● 14 - 10 pcs/box	● 11 - 4 pcs/box	● 17 - 10 pcs/box	● 25 - 10 pcs/box					
68160 BIANCO 68161 BEIGE 68162 ORO 68163 NOCE 68164 GRIGIO	68150 BIANCO 68151 BEIGE 68152 ORO 68153 NOCE 68154 GRIGIO	68170 BIANCO 68171 BEIGE 68172 ORO 68173 NOCE 68174 GRIGIO	68130 BIANCO 68131 BEIGE 68132 ORO 68133 NOCE 68134 GRIGIO	68120 BIANCO 68121 BEIGE 68122 ORO 68123 NOCE 68124 GRIGIO					
S		S		S		M		M	
● 18 - 4 pcs/box	● 21 - 4 pcs/box	● 19 - 36 pcs/box	● 20 - 6 pcs/box	● 20 - 6 pcs/box					
68140 BIANCO 68141 BEIGE 68142 ORO 68143 NOCE 68144 GRIGIO	68110 BIANCO 68111 BEIGE 68112 ORO 68113 NOCE 68114 GRIGIO	12520 BIANCO 12521 BEIGE 12522 ORO 12523 NOCE 12524 GRIGIO	68040 ARGENTO 0,5x60 68045 ARGENTO 1x60	68041 BRONZO 0,5x60 68046 BRONZO 1x60					

RIVESTIMENTO Wall tile Revêtement mural Wand Revestimiento pared Облицовка 墙砖	QUARTO FUOCO Fourth firing Quatrième feu Viert-Brand Cocción a cuarto fuego Четвертый обжиг 四次烧成	SERIGRAFIA Screen printing Sérigraphie Serigraphie Serigrafia Сериграфия 丝网印刷	STAMPA AD ALTA RISOLUZIONE High-definition printing Impression haute résolution Hochauflösungsdruck Impresión de alta resolución Печать с высоким разрешением 高分辨率印刷	PHYSICAL VAPOUR DEPOSITION
TAGLIO A IDROGETTO Water-jet cutting Découpe à hydrojet Wasserstrahl-schnittr Corta con hydro-jet Водометная резка 水刀切割	PREINCISO Pre-cut Pré-incisé Voreingeschnitten Mosaico de pre-corte Предварительно надрезанный 预割	METALLO Metal Métal Metall Metal Металл 金属	METALLO PREZIOSO Precious metals Métaux précieux Edelmetalle Metales preciosos драгоценный металл 贵金属	

Venere è un prodotto di Ceramiche Gardenia Orchidea. Per le caratteristiche tecniche, le avvertenze di installazione e le regole in materia di pulizia e manutenzione del prodotto, non riportate nella presente documentazione, si rimanda alle specifiche contenute nel catalogo generale Gardenia Orchidea.

Venere is a product of Ceramiche Gardenia Orchidea. For the technical characteristics, the tiling instructions and the details on cleaning and maintaining the product which are not indicated in this documentation, please refer to the information provided in Gardenia Orchidea's general catalogue.

Venere est un produit Ceramiche Gardenia Orchidea. Pour les caractéristiques techniques, les conseils de pose et pour connaître la marche à suivre en ce qui concerne le nettoyage courant et les soins d'entretien du produit qui ne sont pas indiqués dans cette documentation, voir le catalogue général Gardenia Orchidea.

Venere ist ein Produkt von Ceramiche Gardenia Orchidea. Für die technischen Eigenschaften, die Hinweise zur Verlegung und die Anweisungen für die Reinigung und Pflege, die in diesen Unterlagen nicht angegeben wurden, berücksichtigen Sie bitte die Angaben des allgemeinen Katalogs von Gardenia Orchidea.

Venere es un producto de Ceramiche Gardenia Orchidea. Para las características técnicas, las instrucciones de instalación, así como para las reglas en materia de limpieza y mantenimiento del producto, que no se encuentran en esta documentación, les remitimos a las especificaciones contenidas en el catálogo general Gardenia Orchidea.

Venere -это изделия компании Ceramiche Gardenia Orchidea. Ознакомьтесь с техническими характеристиками, с инструкциями по укладке и правилами по чистке и уходу за плиткой, которые не представлены в данном документе, вы сможете в специальном разделе генерального каталога Gardenia Orchidea.

Venere 是 Ceramiche Gardenia Orchidea 的产品系列。安装警告以及关于产品清洁保养方面的法律和规则，请参阅 Gardenia Orchidea 产品总目录中的说明。

Le forniture sono effettuate alle condizioni generali di vendita di Ceramiche Gardenia Orchidea riportate sul catalogo generale.

Supplies are carried out under the Ceramiche Gardenia Orchidea general conditions of sale and supply as written on the general catalogue.

Les fournitures son effectuées selon les conditions générales de vente Ceramiche Gardenia Orchidea comme indiqué sur le catalogue général.

Die Lieferungen werden nach den generalen Verkaufskonditionen von Ceramiche Gardenia Orchidea durchgeführt, wie sie auf dem generalen Katalog aufgeführt sind.

Los suministros son efectuados según las condiciones generales de venta Gardenia Orchidea que estan indicadas en el catálogo general.

поставки осуществляются на условиях компании Ceramiche Gardenia Orchidea, приведенных в общем каталоге

공급은 Ceramiche Gardenia Orchidea의 일반 판매 조건에 따라 이루어지며, 이는 일반 카탈로그에 나와 있습니다.

IMBALLI E PESI • PACKINGS AND WEIGHTS • EMBALLAGES ET POIDS • VERPACKUNGEN UND GEWICHTE • EMBALAJES Y PESOS • УПАКОВКИ И ВЕС • 包装和重量

EN 14411/L BIII GL

FORMATO SIZE	pz/mq pcs/sqm	pz/scat. pcs/box	mq/scat. sqm/box	kg/mq kg/sqm	kg/scat. kg/box	scat./pal box/pal	mq/pal sqm/pal	kg/pal
Rivestimenti 25x60	7	8	1,200	15,97	19,16	48	57,60	919,96
Boiserie 25x60	-	4	-	-	9,60	-	-	-
Battiscopa 15x25	-	12	3,00 ml	-	3,36	-	-	-
Angolo battiscopa 15x2	-	4	-	-	0,10	-	-	-
Composizione 50x60	-	1	-	-	5,00	-	-	-
Listello 3x60	-	5	3,00 ml	-	1,41	-	-	-
Listello 3x25	-	12	3,00 ml	-	1,34	-	-	-
Listello 7,8x60	-	4	2,40 ml	-	2,97	-	-	-
Listello 7,8x25	-	6	1,50 ml	-	1,86	-	-	-
Tozzetto 3x3	-	4	-	-	0,04	-	-	-
Girospicchio 7,8x7,8	-	4	-	-	0,42	-	-	-
Colonna 19,7x39,4	-	4	-	-	6,80	-	-	-
Terminale colonna 8x19,7	-	4	-	-	1,60	-	-	-
Matita 1x25	-	36	9,00 ml	-	2,16	-	-	-
Matita 1x60	-	10	6,00 ml	-	1,50	-	-	-
Angolo matita 1x1	-	4	-	-	0,01	-	-	-
Torello 4x25	-	10	2,50 ml	-	2,00	-	-	-
Torello 4x60	-	10	6,00 ml	-	4,80	-	-	-
Angolo torello	-	10	-	-	0,10	-	-	-
Coprispigo 1x33,3	-	36	12,00 ml	-	1,32	-	-	-
Profili metallo 0,5x60	-	6	3,60 ml	-	0,42	-	-	-
Profili metallo 1x60	-	6	3,60 ml	-	0,42	-	-	-

VERSACE
HOME

produttore autorizzato
ceramica, accessori e complementi d'arredo bagno

 **GARDENIA
ORCHIDEA**

Spezzano MO (Italy)
tel +39.0536.849611 • fax +39.0536.849856
www.gardenia.it • www.versacecd.com
e-mail:info@versacecd.com

"All marks created by GIANNI VERSACE S.p.A. Milano, Italy - Trade marks rights reserved to GIANNI VERSACE S.p.A. Milano and its successors in title".

Nessuna iniziativa pubblicitaria potrà essere intrapresa se non previamente autorizzata volta per volta e per iscritto da GIANNI VERSACE S.p.A.
No advertising initiative can be undertaken without previous written authorization given each time
by GIANNI VERSACE S.p.A.

Direzione e coordinamento a cura di: Massimo Bonezzi
Catalogo: Versace Home Venere
Finito di stampare a Bologna nel mese di Dicembre 2012 presso Grafiche dell'Artiere s.r.l.,
Via Romagnoli 5/2, 40010 Bentivoglio (Bologna), Italia
Edito da: Ceramiche Gardenia Orchidea S.p.A., Via Canaletto 27, 41042 Spezzano di Fiorano (Modena), Italia
I Edizione: Maggio 2011
II Edizione: Gennaio 2012
Ultima Edizione: Dicembre 2012

"La proprietà intellettuale del presente catalogo è riservata per tutti i Paesi. La traduzione, riproduzione, memorizzazione elettronica e l'adattamento totale o parziale e con qualsiasi mezzo (compresi microfilm e le copie fotostatiche) dei suoi contenuti comporta la violazione dei diritti di copyright di Ceramiche Gardenia Orchidea S.p.A. I prodotti raffigurati nelle immagini del presente catalogo sono protetti secondo la normativa vigente in materia di proprietà industriale."

"All the intellectual property rights of this catalogue are reserved in all countries. Translation, reproduction in print or electronic form, and adaptation, in whole or in part, using any means (including microfilm and photocopy formats) of the contents of the said catalogue constitute a violation of Ceramiche Gardenia Orchidea S.p.A.'s copyright. The products featured in the photographs in this catalogue are protected by current industrial property legislation."

Ceramics of Italy

• I colori possono risultare falsati dai procedimenti litografici.
• The colours could be altered by the lithographic printing process.
• Les couleurs peuvent résulter faussées par les procédés lithographiques.
• Durch die Lithographie können farbliche Täuschungen entstehen.
• Los colores pueden resultar falseados por los procedimientos litográficos.
• ЦВЕТА МОГУТ БЫТЬ ИСКАЖЕНЫ ВСЛЕДСТВИЕ ЛИТОГРАФИЧЕСКОЙ ОБРАБОТКИ.
• 顏色可透過平版印刷處理而改變



 **GARDENIA
ORCHIDEA**

Spezzano MO (Italy) • tel +39.0536.849611 • fax +39.0536.849856
www.gardenia.it • www.versacecd.com • e-mail: info@versacecd.com

cod. 6001535