

SHAPES#4

DUNE

ceramics

(Ceramica / Ceramic)



www.dune.es

52 53

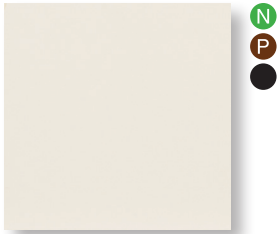

187574 Transverse 1 Clay
14,7x14,7 cm./5.8"x5.8" M963
14 mm. de espesor/thickness

52 54 55

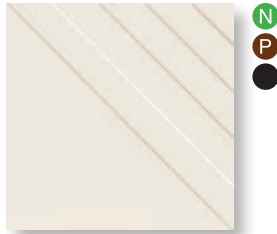

187578 Transverse 2 Clay
14,7x14,7 cm./5.8"x5.8" M963
13 mm. de espesor/thickness

52 56

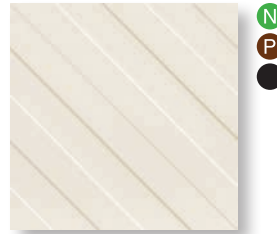

187571 Transverse 3 Clay
14,7x14,7 cm./5.8"x5.8" M963
11 mm. de espesor/thickness

60

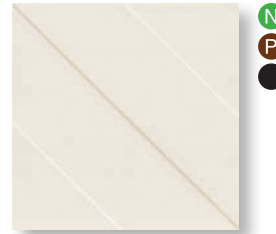

187580 Transverse 4 Clay
14,7x14,7 cm./5.8"x5.8" M963
10 mm. de espesor/thickness

55



187618 Transverse 2 Crackle
14,7x14,7 cm./5.8"x5.8" D55
13 mm. de espesor/thickness

56

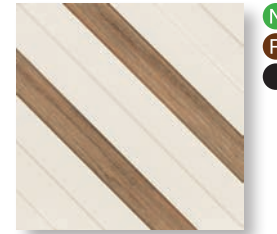

187617 Transverse 3 Wood
14,7x14,7 cm./5.8"x5.8" D55
11 mm. de espesor/thickness

53

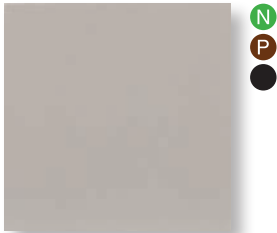

187575 Transverse 1 Cement
14,7x14,7 cm./5.8"x5.8" M963
14 mm. de espesor/thickness

55

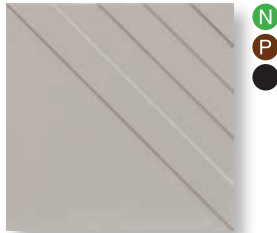

187579 Transverse 2 Cement
14,7x14,7 cm./5.8"x5.8" M963
13 mm. de espesor/thickness

56

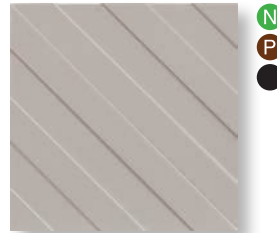

187572 Transverse 3 Cement
14,7x14,7 cm./5.8"x5.8" M963
11 mm. de espesor/thickness

58



187581 Transverse 4 Cement
14,7x14,7 cm./5.8"x5.8" M963
10 mm. de espesor/thickness

54

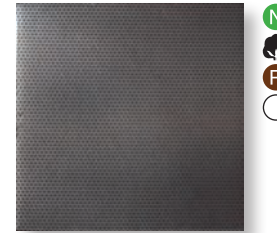

187627 Transverse 1 Metal
14,7x14,7 cm./5.8"x5.8" D55
14 mm. de espesor/thickness

54 57

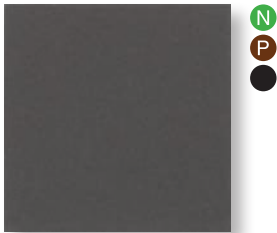

187576 Transverse 1 Graphite
14,7x14,7 cm./5.8"x5.8" M963
14 mm. de espesor/thickness

52 57

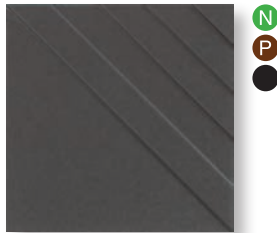

187577 Transverse 2 Graphite
14,7x14,7 cm./5.8"x5.8" M963
13 mm. de espesor/thickness

57

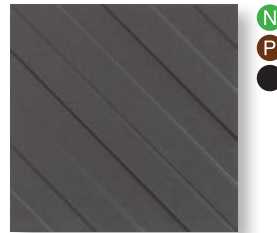

187573 Transverse 3 Graphite
14,7x14,7 cm./5.8"x5.8" M963
11 mm. de espesor/thickness

58 59 61



187582 Transverse 4 Graphite
14,7x14,7 cm./5.8"x5.8" M963
10 mm. de espesor/thickness

60



187628 Transverse 4 Luce
14,7x14,7 cm./5.8"x5.8" M976
10 mm. de espesor/thickness

61

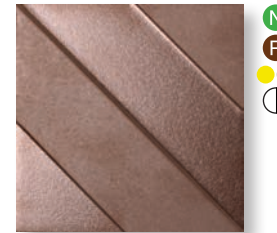

187610 Transverse 4 Copper
14,7x14,7 cm./5.8"x5.8" D280
10 mm. de espesor/thickness

Japan

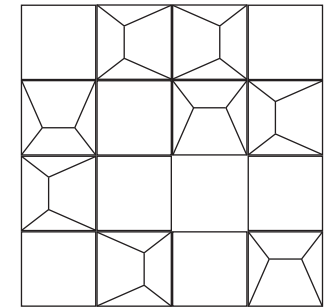
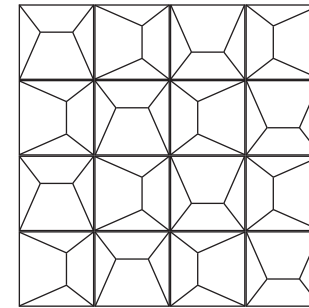
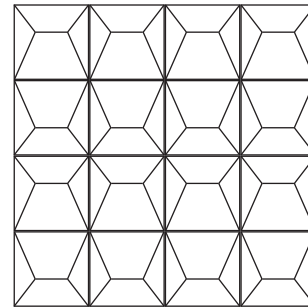
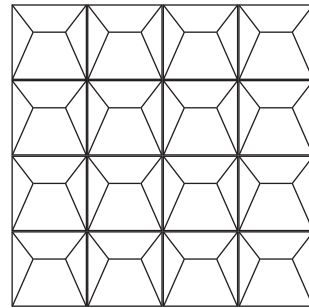
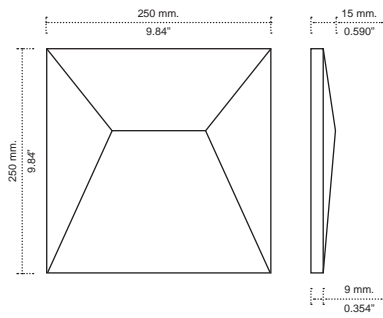

Kioto

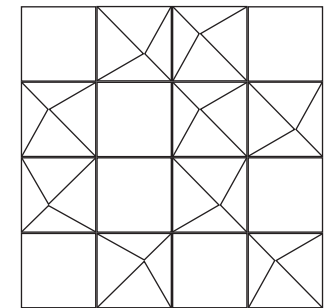
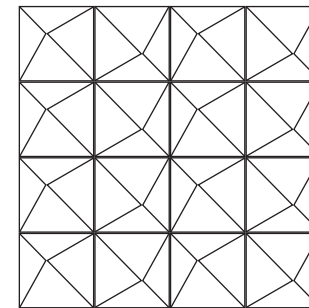
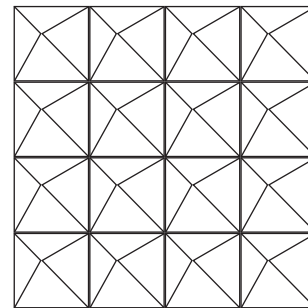
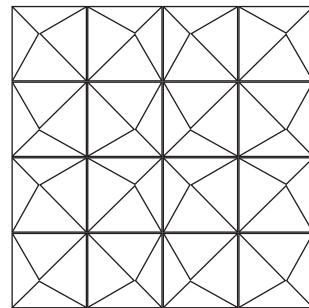
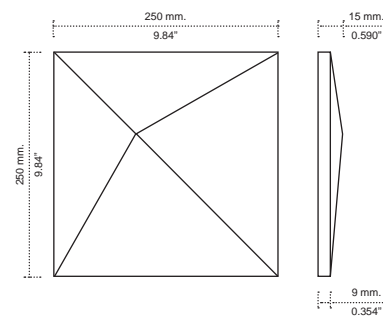

Origami

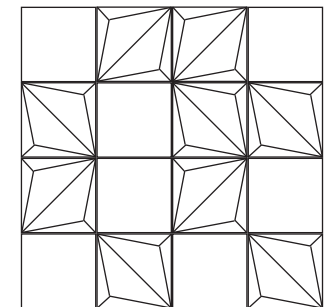
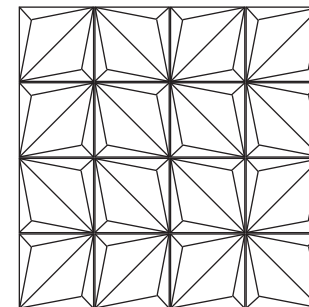
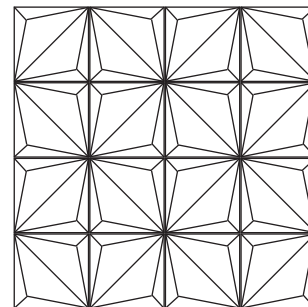
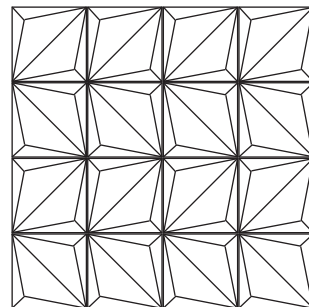
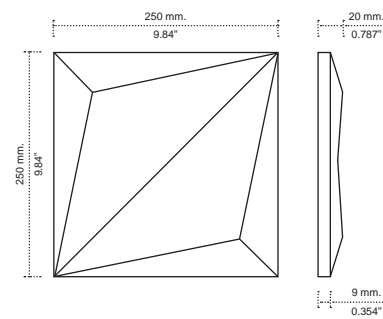

Multishapes

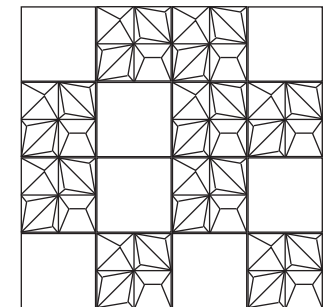
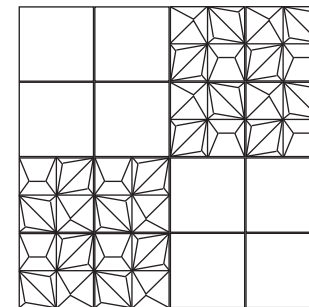
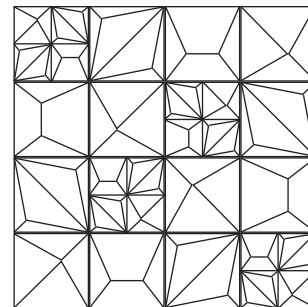
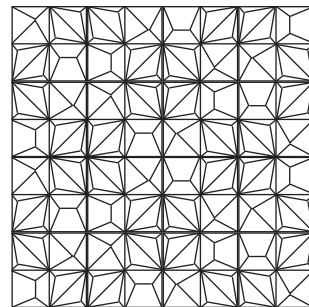
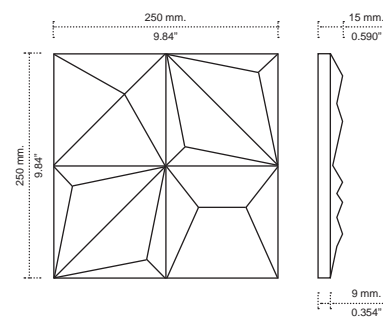

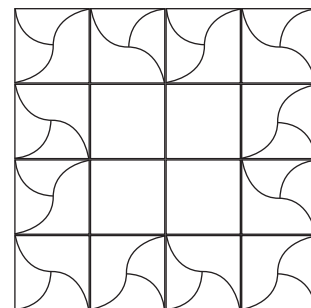
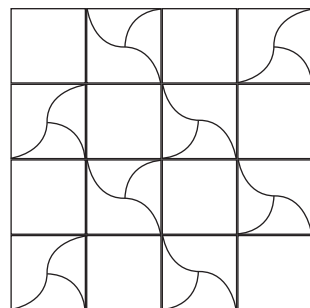
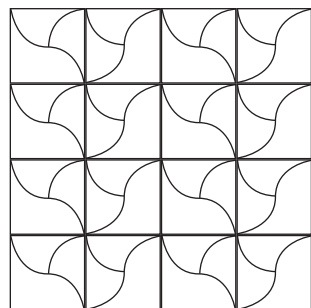
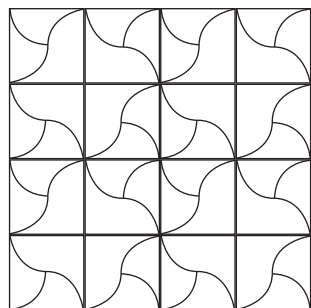
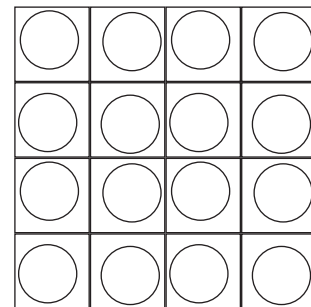
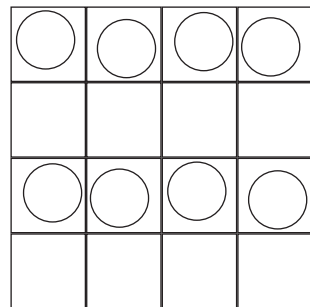
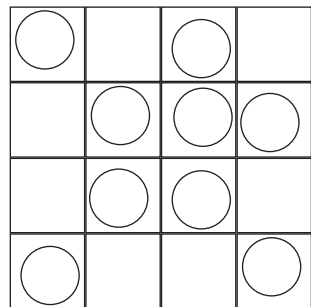
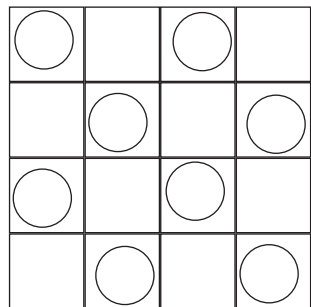
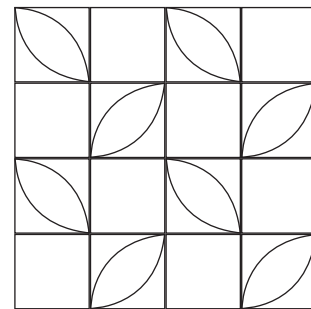
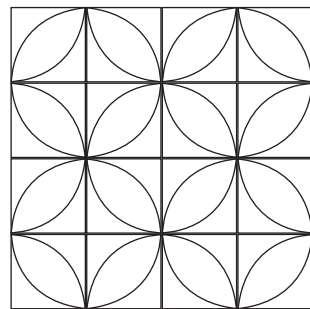
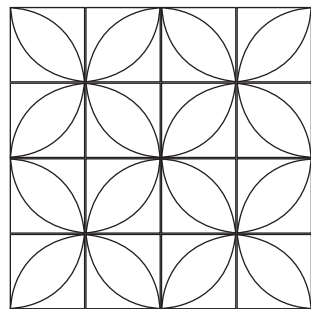
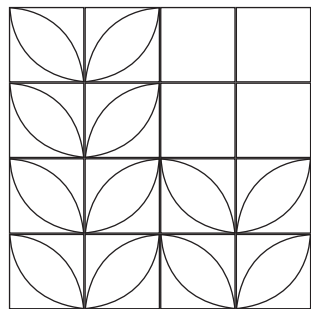
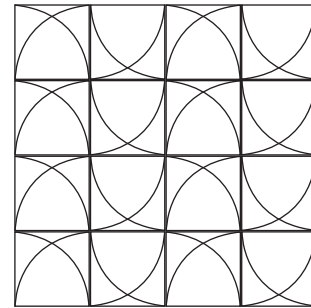
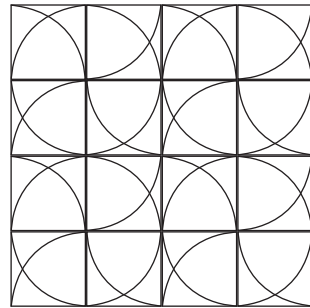
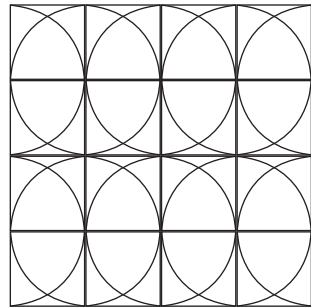
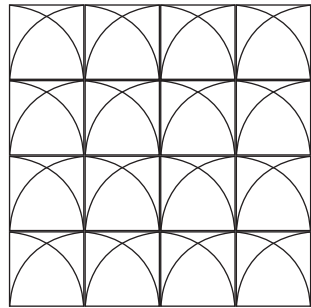

Bivio

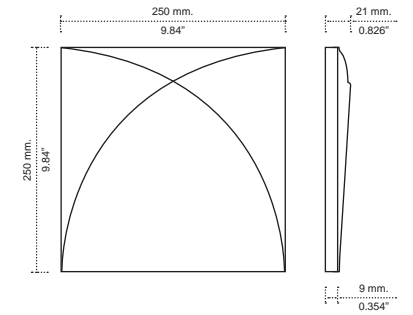

Mandorla

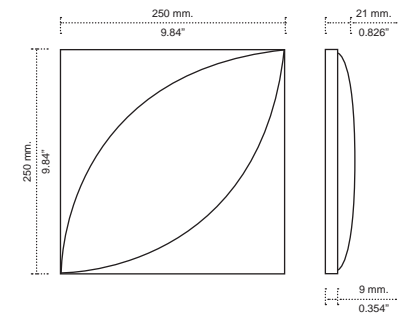

Luna

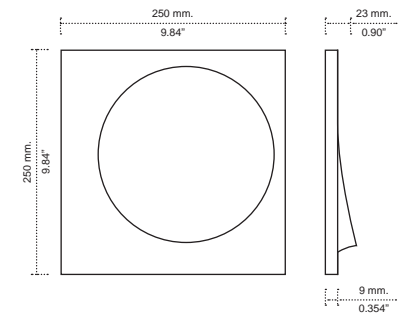

Aria

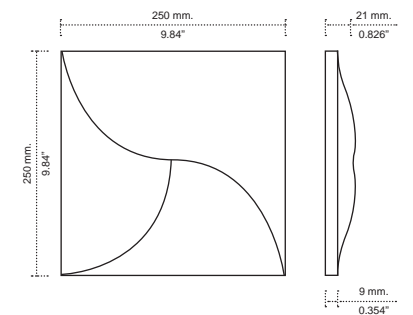



Stripes

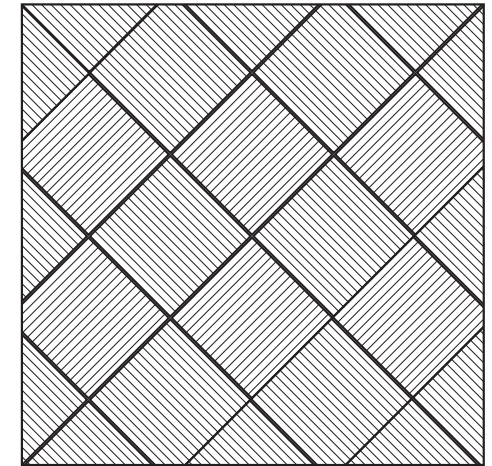
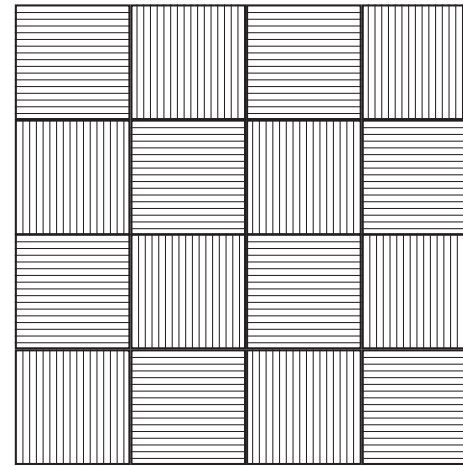
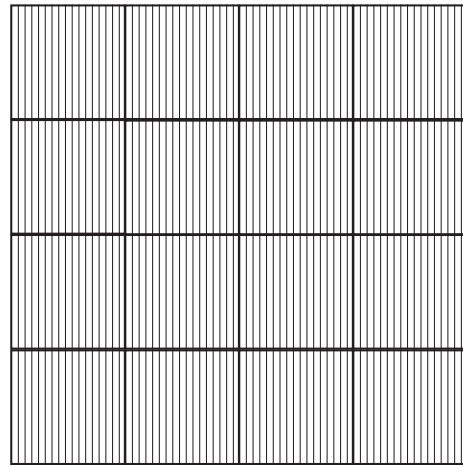
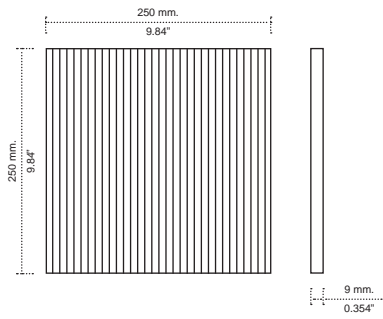

Stripes Mix

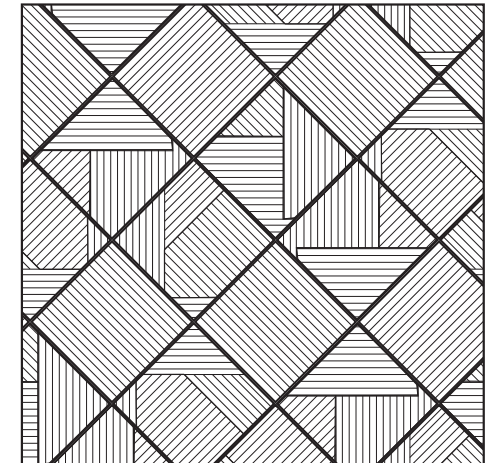
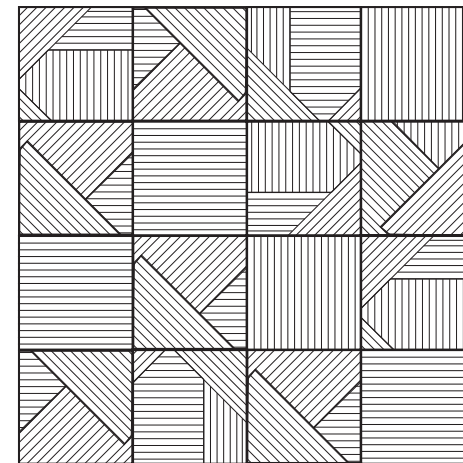
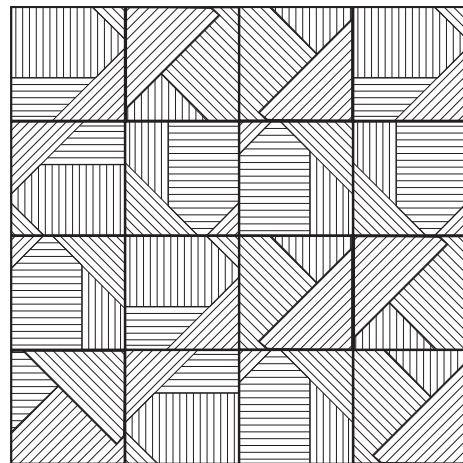
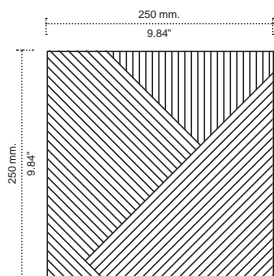
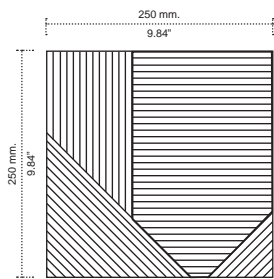

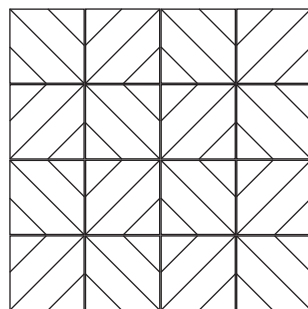
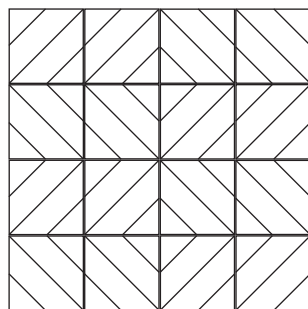
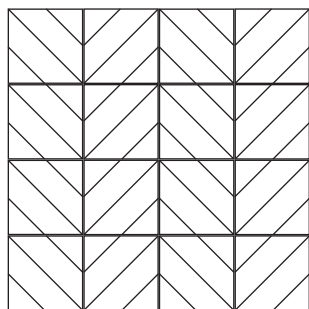
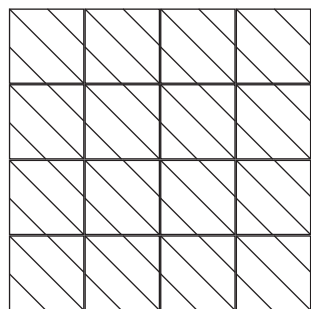
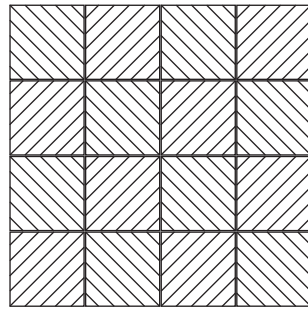
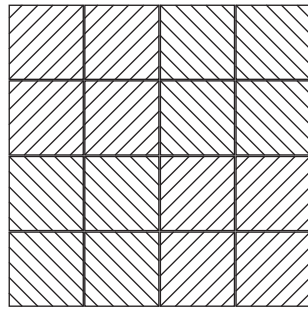
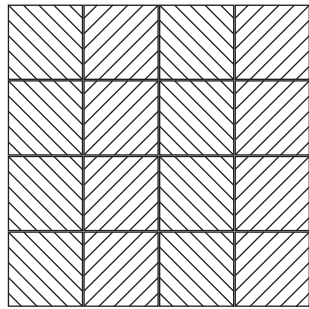
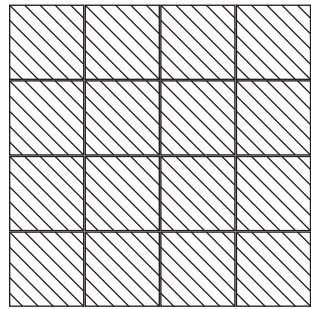
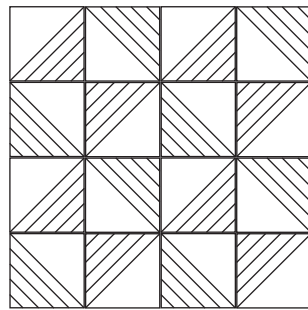
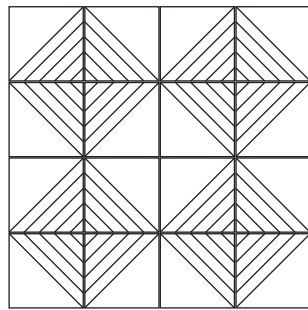
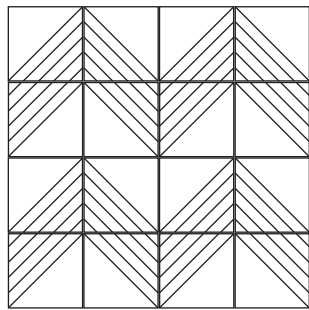
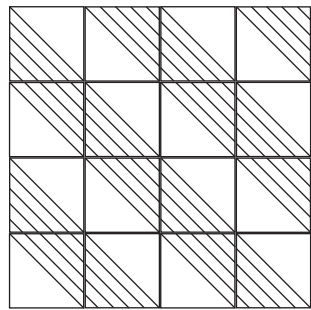
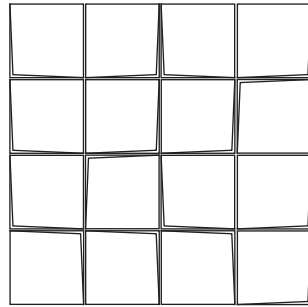
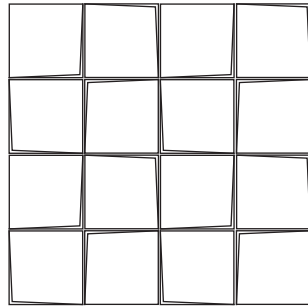
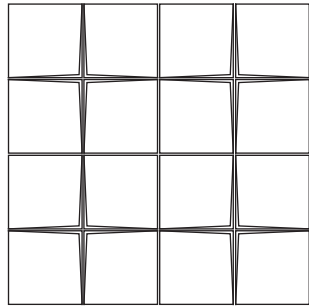
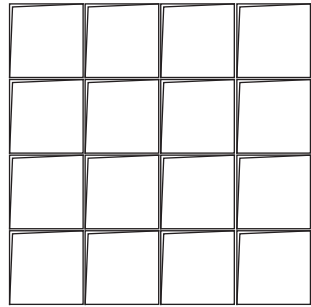

Transverse 1

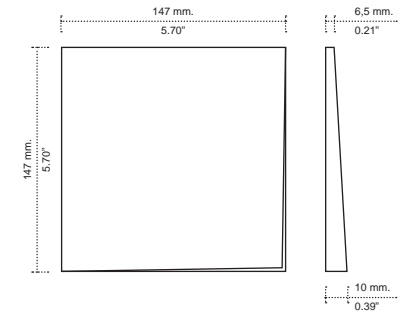

Transverse 2

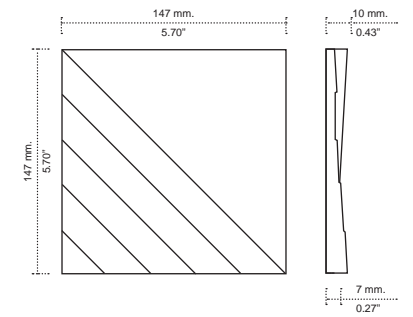

Transverse 3

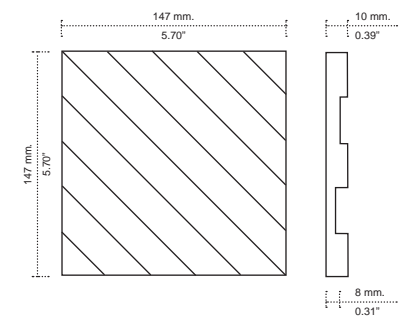

Transverse 4

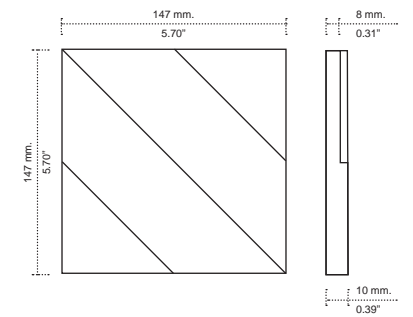

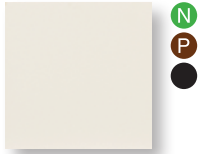

N
P
●

187574 Transverse 1 Clay
14,7x14,7 cm./5.8"x5.8" M963
14 mm. de espesor/thickness

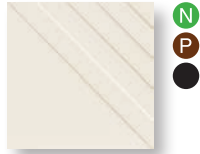

N
P
●

187578 Transverse 2 Clay
14,7x14,7 cm./5.8"x5.8" M963
13 mm. de espesor/thickness

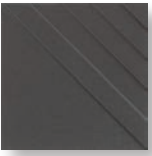

N
P
●

187577 Transverse 2 Graphite
14,7x14,7 cm./5.8"x5.8" M963
13 mm. de espesor/thickness



N
P
●

187571 Transverse 3 Clay
14,7x14,7 cm./5.8"x5.8" M963
11 mm. de espesor/thickness



N
P
R
●

187531 Fancy Grey Rec
60x120 cm./23.6"x47.2" M935
11 mm. de espesor/thickness (Clase 1/Class 1)



N

187551 Rodapie Fancy Grey Rec
9,5x60 cm./3.7"x23.6" D118
10 mm. de espesor/thickness



- N Novedad / New
- P Porcelánico / Porcelain
- R Rectificado / Rectified
- Acabado Mate/Mat Finish

m ²		Kg	Lbs		m	m ²												
1,39	2	35,88	79,1	27	1,44	38,88	Fancy Grey Rec	●	●	●	●	●	C	●	●	C	●	●
17,54	12	16,8	37,04	70	0,68	47,88	Rodapie Fancy Grey Rec	●	●	●	●	●	●	●	●	●	●	●
46,28	42	19,74	43,52	70	0,91	63,53	Transverse 1 Clay	●	●	●	●	●	●	●	●	●	●	●
46,28	38	16,91	37,28	70	0,82	57,48	Transverse 2 Clay	●	●	●	●	●	●	●	●	●	●	●
46,28	38	16,91	37,28	70	0,82	57,48	Transverse 2 Graphite	●	●	●	●	●	●	●	●	●	●	●
46,28	36	15,84	34,92	70	0,78	54,45	Transverse 3 Clay	●	●	●	●	●	●	●	●	●	●	●

● = Ok C = Consultar/Consult



DUNE



P
R
●

187292 Smoke Rec
60x60 cm./23.6"x23.6" M920
10 mm. de espesor/thickness (Clase 0/Class 0)

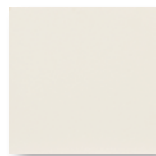

N
P
●

187574 Transverse 1 Clay
14,7x14,7 cm./5.8"x5.8" M963
14 mm. de espesor/thickness



N
P
●

187575 Transverse 1 Cement
14,7x14,7 cm./5.8"x5.8" M963
14 mm. de espesor/thickness

- N Novedad / New
- P Porcelánico / Porcelain
- R Rectificado / Rectified
- Acabado Mate/Mat Finish

m ²	□	Kg	Lbs	□	m	m'		🏠	☀️	🌿	🌊	🏠	📊	🚿	🌊	🚰	
2,78	3	23,07	50,86	40	1,08	43,2	Smoke Rec	●	●	●	●	C	●	●	C	●	●
46,28	42	19,74	43,52	70	0,91	63,53	Transverse 1 Cement	●	●	●	●	●	●	●	●	●	●
46,28	42	19,74	43,52	70	0,91	63,53	Transverse 1 Clay	●	●	●	●	●	●	●	●	●	●

● = Ok C = Consultar/Consult



P
R
●

187292 Smoke Rec
60x60 cm./23.6"x23.6" M920
10 mm. de espesor/thickness



N
P
●

187576 Transverse 1 Graphite
14,7x14,7 cm./5.8"x5.8" M963
14 mm. de espesor/thickness



N
P
●
○

187627 Transverse 1 Metal
14,7x14,7 cm./5.8"x5.8" D55
14 mm. de espesor/thickness

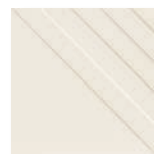

N
P
●

187578 Transverse 2 Clay
14,7x14,7 cm./5.8"x5.8" M963
13 mm. de espesor/thickness

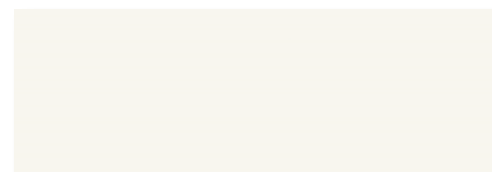

N
R
●

187146 Just White Matt
29,5x90,1 cm./11.6"x35.5" M924
12 mm. de espesor/thickness



P
R
●

187291 Mist Rec
60x60 cm./23.6"x23.6" M920
10 mm. de espesor/thickness (Clase 0/Class 0)

- N Novedad / New
- Producto delicado / Delicate product
- P Porcelánico / Porcelain
- R Rectificado / Rectified
- Acabado Brillo/Glossy Finish
- Acabado Mate/Mat Finish

m ²		Kg	Lbs		m	ft											
3,77	4	23,6	52,03	28	1,06	29,74	Just White Matt	●	●					●	●		
2,78	3	23,13	50,99	40	1,08	43,2	Mist Rec	●	●	●	●	C	●	●	C	●	●
2,78	3	23,07	50,86	40	1,08	43,2	Smoke Rec	●	●	●	●	C	●	●	C	●	●
46,28	42	19,74	43,52	70	0,91	63,53	Transverse 1 Graphite	●	●	●	●		●	●		●	●
46,28	42	18,06	39,82	70	0,91	63,53	Transverse 1 Metal	●	●	●				●		●	●
46,28	38	16,91	37,28	70	0,82	57,48	Transverse 2 Clay	●	●	●				●	●	●	●

● = Ok C = Consultar/Consult

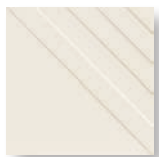

N
P
●

187578 Transverse 2 Clay
14,7x14,7 cm./5.8"x5.8" M963
13 mm. de espesor/thickness



N
P
●

187618 Transverse 2 Crackle
14,7x14,7 cm./5.8"x5.8" D55
13 mm. de espesor/thickness

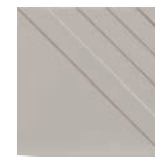

N
P
●

187579 Transverse 2 Cement
14,7x14,7 cm./5.8"x5.8" M963
13 mm. de espesor/thickness

- N Novedad / New
- P Porcelánico / Porcelain
- Acabado Mate/Mat Finish
- ◐ Acabado Satinado ó Mix Brillo-Mate / Satin Finish or Mix Glossy-Mat

m ²	kg	Kg	Lbs	ft ²	m	m'		☀	☔	🏠	🏢	🚿	🌊	♿
46,28	38	16,91	37,28	70	0,82	57,48	Transverse 2 Cement	●	●	●		●	●	●
46,28	38	16,91	37,28	70	0,82	57,48	Transverse 2 Clay	●	●	●		●	●	●
46,28	38	17,1	37,7	70	0,82	57,48	Transverse 2 Crackle	●	●	●		●	●	●

● = Ok C = Consultar/Consult

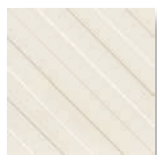

N
P
●

187571 Transverse 3 Clay
14,7x14,7 cm./5.8"x5.8" M963
11 mm. de espesor/thickness

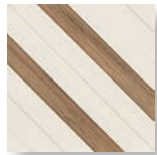

N
P
●

187617 Transverse 3 Wood
14,7x14,7 cm./5.8"x5.8" D55
11 mm. de espesor/thickness

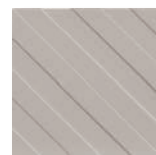

N
P
●

187572 Transverse 3 Cement
14,7x14,7 cm./5.8"x5.8" M963
11 mm. de espesor/thickness



P
●

187324 Aosta Argent
22x85 cm./8.7"x33.5" M849
9 mm. de espesor/thickness (Clase 1/Class 1)

- N Novedad / New
- P Porcelánico / Porcelain
- Acabado Mate/Mat Finish

m² Kg Lbs m m²

5,35	8	30,32	66,84	45	1,5	75,73
46,28	36	15,84	34,92	70	0,78	54,45
46,28	36	15,84	34,92	70	0,78	54,45
46,28	36	16,2	35,71	70	0,78	54,45



Aosta Argent	●	●	●	●	●	●	●	●	●	●	●	●
Transverse 3 Cement	●	●	●	●	●	●	●	●	●	●	●	●
Transverse 3 Clay	●	●	●	●	●	●	●	●	●	●	●	●
Transverse 3 Wood	●	●	●	●	●	●	●	●	●	●	●	●

● = Ok C = Consultar/Consult



N
P
●

187573 Transverse 3 Graphite
14,7x14,7 cm./5.8"x5.8" M963
11 mm. de espesor/thickness



N
P
●

187576 Transverse 1 Graphite
14,7x14,7 cm./5.8"x5.8" M963
14 mm. de espesor/thickness

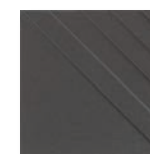

N
P
●

187577 Transverse 2 Graphite
14,7x14,7 cm./5.8"x5.8" M963
13 mm. de espesor/thickness

- N Novedad / New
- P Porcelánico / Porcelain
- Acabado Mate/Mat Finish

m ²	kg	Lbs	m	m ²	Transverse 1 Graphite	Transverse 2 Graphite	Transverse 3 Graphite
46,28	42	19,74	43,52	70	0,91	63,53	• • • • • • • • • •
46,28	38	16,91	37,28	70	0,82	57,48	• • • • • • • • • •
46,28	36	15,84	34,92	70	0,78	54,45	• • • • • • • • • •

● = Ok C = Consultar/Consult



- N
- P
-

187581 Transverse 4 Cement
14,7x14,7 cm./5.8"x5.8" M963
10 mm. de espesor/thickness



- N
- P
-

187582 Transverse 4 Graphite
14,7x14,7 cm./5.8"x5.8" M963
10 mm. de espesor/thickness



- N Novedad / New
- P Porcelánico / Porcelain
- Acabado Mate/Mat Finish

m ²	kg	Lbs	mm	m ²															
46,28	41	17,63	38,87	70	0,89	62,02	Transverse 4 Cement	●	●	●	●	●	●	●	●	●	●	●	●
46,28	41	17,63	38,87	70	0,89	62,02	Transverse 4 Graphite	●	●	●	●	●	●	●	●	●	●	●	●

● = Ok C = Consultar/Consult

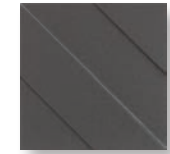

N
P
●

187582 Transverse 4 Graphite
14,7x14,7 cm./5.8"x5.8" M963
10 mm. de espesor/thickness



N
R
●

187521 Calacatta Lux
29,5x90,1 cm./11.6"x35.5" M925
12 mm. de espesor/thickness

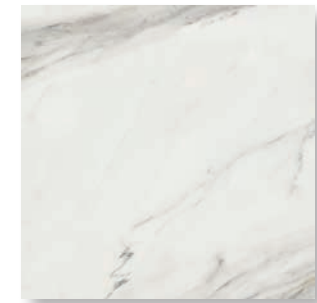

N
●
P
R
○
P

187555 Calacatta Lux Rec
60x60 cm./23.6"x23.6" M969
10 mm. de espesor/thickness (Clase 0 / Class 0)



N
●
●
○

187622 Valvula One Touch Inox
9x65 cm./3.5"x25.6" E25
1 mm. de espesor/thickness



N
○

187625 Lavabo Marquina
42x42x14 cm./16.5"x16.5"x5.5" E270
12 mm. de espesor/thickness

- N Novedad / New
- Producto delicado / Delicate product
- P Porcelánico / Porcelain
- R Rectificado / Rectified
- ● Aplicación metálica PVD / Metallic application PVD
- Acabado Brillo/Glossy Finish
- Acabado Mate/Mat Finish
- P Acabado Pulido/Polished Finish

m ²	Paquetes	Kg	Lbs	Paquetes	m ²	m ²											
3,76	4	23,6	52,03	28	1,06	29,77	Calacatta Lux	●	●								
2,78	3	23,91	52,71	36	1,08	38,88	Calacatta Lux Rec	●	C	●	●	C	●	C	●		
5,67	1	12	26,46	16	0,18	2,82	Lavabo Marquina										
46,28	41	17,63	38,87	70	0,89	62,02	Transverse 4 Graphite	●	●	●							
170,94	50	15	33,07	24	0,29	7,02	Valvula One Touch Inox										

● = Ok C = Consultar/Consult

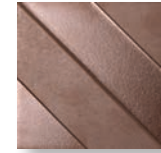

187610 Transverse 4 Copper
14,7x14,7 cm./5.8"x5.8" D280
10 mm. de espesor/thickness

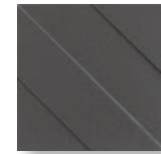

187582 Transverse 4 Graphite
14,7x14,7 cm./5.8"x5.8" M963
10 mm. de espesor/thickness



187602 Lavabo Extreme Duo
35x35x12 cm./13.8"x13.8"x4.7" E650
12 mm. de espesor/thickness



187624 Valvula One Touch Copper
9x65 cm./3.5"x25.6" E25
1 mm. de espesor/thickness

- N Novedad / New
- P Porcelánico / Porcelain
- ● Aplicación metálica PVD / Metallic application PVD
- Acabado Brillo/Glossy Finish
- Acabado Mate/Mat Finish
- ◐ Acabado Satinado ó Mix Brillo-Mate / Satin Finish or Mix Glossy-Mat

m ²	kg	Lbs	cm	m	m ²							
8,16	1	8,5	18,74	16	0,12	1,96	Lavabo Extreme Duo					
46,28	38	16,34	36,02	70	0,82	57,48	Transverse 4 Copper	●	●	●	●	●
46,28	41	17,63	38,87	70	0,89	62,02	Transverse 4 Graphite	●	●	●	●	●
170,94	50	15	33,07	24	0,29	7,02	Valvula One Touch Copper					

● = Ok C = Consultar/Consult