

ARIOSTEA®

H
C
O
T
E
L
-
T
E
C
H
N
I
C
A
L
E
N
G
I
N
E
E
R
I
N
G

EDITION: N.1
MARCH 2016



The background of the entire page is a close-up, high-resolution photograph of a wood surface. The wood grain is prominent, showing various patterns and textures in shades of brown and tan. The lighting is soft, highlighting the natural imperfections and grain of the wood.

COLLECTIONS	6
ULTRA WOOD	8
INNOVATIVE SLABS LEGNI HIGH-TECH	30
LEGNI HIGH-TECH ROVERE 120	56
LEGNI HIGH-TECH ROVERE 90	102
WOODDRAW	132
CM2	156
INFORMATION AND CODES	164

LEGNI HIGH-TECH

I Legni High-Tech sono l'esaltazione della tecnologia. Riproducono in modo incredibilmente fedele l'aspetto, le sensazioni tattili, le venature del parquet. Per avvicinarsi così alla perfezione, non è stata toccata nemmeno una foglia.

La tecnologia produttiva dei Legni High-Tech garantisce ai listoni una resistenza a carichi di rottura eccezionalmente elevata. Questo vuol dire non subire flessioni, non alterare la linearità, non spostarsi di un millimetro, mai. L'impatto visivo è quello del parquet, ma la forza è quella della pietra. Il rigore estetico del design a listoni dei grandi parquet si abbina senza rinunce alle esigenze di resistenza al peso e al carico degli ambienti contemporanei. Sui Legni High-Tech non si vedono i segni del tempo. Compattezza, omogeneità e struttura uniforme li rendono incredibilmente resistenti alle abrasioni più profonde, alle aggressioni chimiche e a quelle di un calpestio infinito nel tempo. I nostri listoni sono unici. Toccare per credere. Questo è il miglior modo per cogliere l'unicità di questi materiali. Ci si ritrova la struttura e il calore del parquet, ma a questa vocazione Ariostea ha aggiunto caratteristiche tecniche che li rendono superiori.

Legni High-Tech are technology taken to its highest level. They reproduce all the appearance, tactile sensations and veins of natural wood, down to the tiniest detail. Yet all this perfection is achieved without harming a single leaf. The production technology of Legni High-Tech slabs guarantees exceptionally high breaking strength. And this means no bending, absolute maintenance of linearity, and no shifting, even by a millimetre. Ever. The visual impact may be that of wood, but they are as strong as stone. And the immaculate "parquet block" floor they create will happily provide all the weight and load resistance required in contemporary installation contexts. On Legni High-Tech, the signs of time are invisible. Compact, homogeneous and with a uniform structure, they are incredibly resistant to the deepest abrasion, chemical attack and infinite traffic over time. Our slabs are unique. You have to touch this material with your own hands to appreciate its unique qualities. It has all the texture and warmth of wood, but Ariostea has combined this vocation with technical characteristics that make them superior.

Die Legni High-Tech sind die Apotheose der Technik. Sie geben die Optik, die Haptik und die Äderungen des Holzes mit verblüffender Naturtreue wieder. Um ein derartiges Maß an Vollkommenheit zu erreichen, wurde kein einziges Zweiglein berührt. Die Herstellungstechnik der Legni High-Tech gewährleistet den Dielen eine außerordentlich hohe Bruchlastbeständigkeit. Damit entstehen keine Verbiegungen, wird die Geradlinigkeit nicht beeinträchtigt und gibt das Material auch keinen einzigen Millimeter nach. Niemals. Die Optik des Holzes und die Kraft des Steins. Die optische Strenge des Dielenmusters von Parkettböden vereint sich kompromisslos mit den Gewichts- und Lastbeständigkeitsanforderungen der modernen Architektur. Auf den Legni High-Tech hinterlässt die Zeit keine Spuren. Kompaktheit, Homogenität und ebene Struktur machen sie unglaublich widerstandsfähig gegenüber Tiefenabrieb, Chemikalien und Trittbearbeitungen. Unsere Dielen sind einzigartig. Wenn Sie Ihren Augen nicht trauen, dann lassen Sie doch einfach die Hand über die Oberflächen gleiten. Damit erkennen Sie am besten die Einzigartigkeit dieser Materialien.

Les Legni High-Tech sont l'exaltation de la technologie. Ils reproduisent avec une incroyable fidélité l'aspect, les perceptions tactiles, les veinures du bois naturel. Et pour atteindre une telle perfection, nous n'avons même pas touché une feuille. La technologie de production des Legni High-Tech permet de garantir une très grande résistance des lamelles à la rupture; c'est-à-dire qu'elles ne subissent aucun fléchissement, que leur alignement n'est pas altéré, qu'elles ne bougent pas d'un millimètre. En aucun cas. Visuellement elles ont l'aspect du bois, mais elles gardent la force de la pierre. La rigueur esthétique du design des grands parquets à lamelles est assortie, sans contraintes, aux exigences de résistance au poids et à la charge des environnements contemporains. L'usure du temps n'apparaît jamais sur les Legni High-Tech. Du fait de leur compacité, de leur homogénéité et de leur structure uniforme, ils sont extrêmement résistants aux abrasions les plus profondes, aux agressions chimiques et au piétinement. Une résistance infinie dans le temps. Nos lames sont uniques. Il faut les toucher pour y croire. C'est la meilleure façon d'appréhender le caractère unique de ces matériaux. On y retrouve la structure et la chaleur du bois; mais Ariostea a ajouté des particularités techniques à cette vocation naturelle.

ULTRA WOOD

6_{mm} THICKNESS
5 COLORS
SOFT FINISH

NOCE
AMERICANO

NOCE
CHIARO

INNOVATIVE SLABS LEGNI HIGH-TECH

8_{mm} THICKNESS
5 COLORS
ANTIQUED FINISH

QUERCIA
CANADESE

QUERCIA
BIANCA

LEGNI HIGH-TECH ROVERE 90

10_{mm} THICKNESS
9 COLORS
ANTIQUED FINISH

ROVERE
GRIGIO

ROVERE
BIANCO

ROVERE
NATURALE

ROVERE
BIONDO

LEGNI HIGH-TECH ROVERE 120

10_{mm} THICKNESS
11 COLORS
ANTIQUED FINISH

ROVERE
TUNDRA

ROVERE
PROVENZALE

ROVERE
CENERE

ROVERE
SABBIA

ROVERE
CORDA

WOODRAW

8_{mm} THICKNESS
5 COLORS
ANTIQUED FINISH

ASH

ARTIC

LEGNI ALL COLLECTIONS

NOCE
CALCE

NOCE
OSSIDATO

NOCE
SCURO



180x21,5 cm

QUERCIA
SHABBY

QUERCIA
PETRAEA

QUERCIA
TROPICALE

150x37,5 cm
150x25 cm
150x18,7 cm

ROVERE
CILIEGIO

ROVERE
MOKA

ROVERE
ANTICO

ROVERE
ABBAZIA

ROVERE
NERO

90x22,5 cm
90x15 cm
90x11 cm

ROVERE
DECAPE

ROVERE
BRICCOLA

ROVERE
NOCE

ROVERE
COUNTRY

ROVERE
IMPERO

ROVERE
REALE

120x30 cm
120x20 cm
120x15 cm

POWDER

BOARD

RUST

120x20 cm

ULTRA[®]

ARIOSTEA[®] HIGHTECH

WOOD

L'elegante tessitura lignea del Noce con le sue formidabili nodosità e striature verticali è proposta dalla nuova collezione ULTRA WOOD nel singolo grande formato 180x21,5 cm. Ariostea interpreta le caratteristiche di durezza e resistenza riconoscibili in questa essenza nei 5 diversi colori e nello spessore di 6 mm.

Walnut refined wooden weaving with its extraordinary knottiness and vertical stripes is proposed by the ultimate ULTRA WOOD collection in single 180x21,5 cm size.

Ariostea impresses hardness and resistance recognizable properties of this essence in 5 different colours and in 6 mm thick tiles.

Die elegante Holz Textur des Nussbaumes mit seine formidable Knorrigkeit und eine vertikale Streifung wird in der neuen Kollektion angeboten: ULTRA WOOD im einzelnen Großformat 180x21,5 cm. Ariostea interpretiert die Eigenschaften der Härte und Beständigkeit erkennbar, unter dieser Essenz, in 5 verschiedene Farben und in der Dicke von 6 mm.

L'élégante texture en bois de noyer avec ses nœuds formidables et ses veines verticales est offerte dans la nouvelle collection ULTRA WOOD en grand format seulement 180x21,5 cm. Ariostea interprète les caractéristiques de résistance et de dureté reconnaissables dans cette essence dans 5 différents coloris et en épaisseur de 6 mm.

6_{mm} THICKNESS
1 SIZE
5 COLORS
SOFT FINISH

180x21,5 cm
72"x8½"

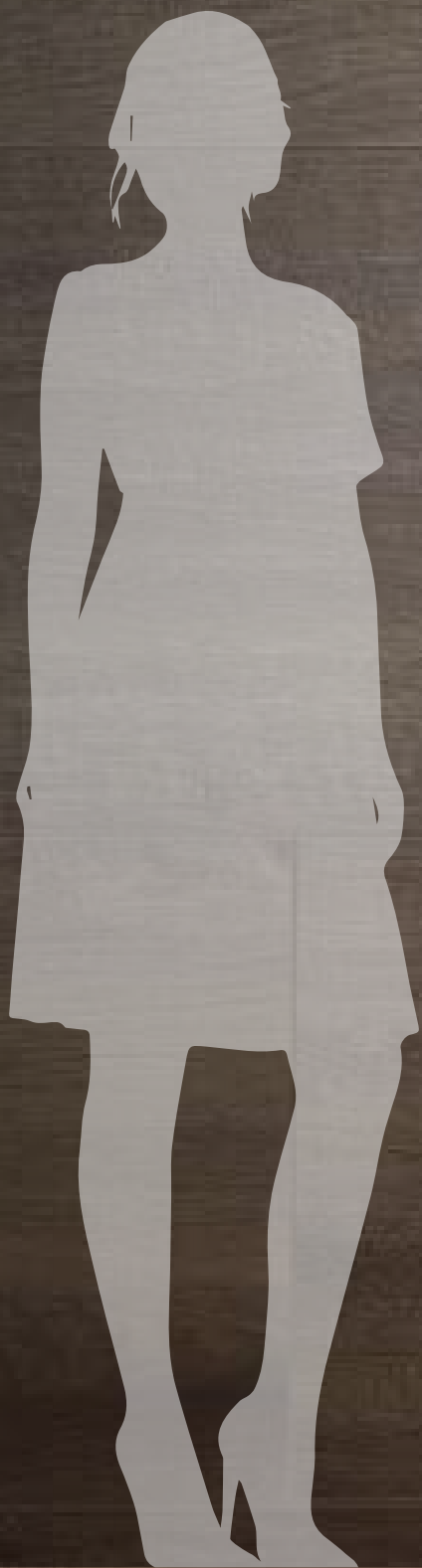

NOCE AMERICANO

NOCE CHIARO

NOCE CALCE

NOCE OSSIDATO

NOCE SCURO

NOCE AMERICANO







Floor and walls: Noce Americano
180x21,5 cm



NOCE OSSIDATO







Floor: Noce Ossidato
180x21,5 cm



Floor: Noce Ossidato
180x21,5 cm

NOCE SCURO







Floor: Noce Scuro
180x21,5 cm



NOCE CALCE







Floor: Noce Calce
180x21,5 cm



Floor: Noce Calce
180x21,5 cm

NOCE CHIARO







Wall: Noce Chiaro
180x21,5 cm







In questi anni in cui il design si accompagna spesso al riutilizzo delle forme e dei materiali migrandoli a nuova vita, Ariostea propone, nel grande formato 150 cm, le doghe di quercia vintage. Tutte le emozioni che solo il tempo, le piogge e il sole sanno lasciare sulle superfici di antica produzione e lasciate all'incuria dell'uomo, si traducono nelle ossidazioni e nelle vibrazioni del legno che vengono restituite anche a livello tattile su questi splendidi materiali per i più svariati usi di rivestimento e pavimentazione.

In these years in which design is often connected with shapes and materials re-use, leading them to a new life, Ariostea presents vintage oak slabs in the large size of 150 cm.

All the emotions that only time, rain and sun can leave on old-time production surfaces and left to man carelessness, turned into oxidation and wood vibrations are rendered on a tactile level in these wonderful materials, ready to the most varied uses of coating and flooring.

In dieser Zeit wird das Design oft durch die Wiederverwendung von Formen und Materialien begleitet, die ihnen neues Leben einhaucht. Ariostea bietet nun im Großformat 150 cm Alteichendauben an. Nur Zeit, Regen und Sonne hinterlassen auf alten Holzoberflächen vergangener Produktionen, die lange Zeit einfach brach lagen, die besonderen Emotionen, Oxidationen und "Schwingungen" des Holzes, die sich auch haptisch äußern. Dies sind wunderschöne Materialien für die unterschiedlichsten Anwendungen als Beschichtung und Bodenbelag.

Ces années, alors que le design est souvent accompagné par la réutilisation des formes et des matériaux en leur donnant une nouvelle vie, Ariostea propose, en grand format de 150 cm, les douves de chêne vintage. Toutes les émotions, que seul le temps, les pluies et le soleil fixent sur les surfaces antiques et délaissées par l'être humain, donnent naissance à l'oxydation et aux vibrations du bois qui sont reproduites même au toucher sur ces merveilleux matériaux adaptés aux utilisations les plus variées du revêtement et des habillements de sol.

INNOVATIVE SLABS LEGNI HIGHTECH

INNOVATIVE SLABS LEGNI HIGHTECH

8_{mm} THICKNESS
3 SIZES
5 COLORS
ANTIQUED FINISH

150x18,7 cm
60"x8"



150x25 cm
60"x10"



150x37,5 cm
60"x15"



QUERCIA SHABBY



QUERCIA BIANCA



QUERCIA PETRAEA



QUERCIA TROPICALE



QUERCIA CANADESE

QUERCIA SHABBY







Floor: Quercia Shabby
150x18,7 cm



Floor: Quercia Shabby
150x18,7 cm

QUERCIA BIANCA







Floor: Quercia Bianca
150x25 - 150x18,7 cm



QUERCIA PETRAEA







Floor: Quercia Petraea
150x25 - 150x18,7 cm



Floor and Wall: Quercia Petraea
150x25 cm

QUERCIA TROPICALE







Floor: Quercia Tropicale
150x37,5 - 150x25 - 150x18,7 cm



QUERCIA CANADESE







Floor and Wall: Quercia Canadese
150x37,5 - 150x25 - 150x18,7 cm







ROVERE 120

LEGNI HIGH-TECH



ROVERE 90

120x15 cm
48"x6"

120x20 cm
48"x8"

120x30 cm
48"x12"

ROVERE TUNDRA

ROVERE PROVENZALE

ROVERE CENERE

ROVERE SABBIA

ROVERE CORDA

ROVERE 120



ROVERE DECAPÉ



ROVERE BRICCOLA



ROVERE NOCE



ROVERE COUNTRY



ROVERE IMPERO



ROVERE REALE

10_{mm} THICKNESS
3 SIZE
11 COLORS
ANTIQUED FINISH

ROVERE TUNDRA







Floor: Rovere Tundra
120x30 - 120x20 - 120x15 cm



Floor: Rovere Tundra
120x30 - 120x20 - 120x15 cm

ROVERE PROVENZALE





SCANDIA
uno stile d'arr
Magnus Englund
fotograf

SCANDIA



Floor: Rovere Provenzale
120x20 - 120x15 cm



Floor: Rovere Provenzale
120x20 - 120x15 cm

ROVERE CENERE







Floor: Rovere Cenere
120x30 - 120x20 - 120x15 cm



Floor: Rovere Cenere
120x30 - 120x20 - 120x15 cm

ROVERE SABBIA







Floor: Rovere Sabbia
120x30 - 120x20 - 120x15 cm



Floor: Rovere Sabbia
120x30 - 120x20 - 120x15 cm

ROVERE CORDA







Floor: Rovere Corda
120x20 - 120x15 cm



Floor: Rovere Corda
120x15 cm

ROVERE DECAPÉ







Floor: Rovere Decapè
120x30 - 120x20 - 120x15 cm



Floor: Rovere Decapè
120x30 - 120x20 - 120x15 cm

ROVERE BRICCOLA







Floor: Rovere Briccola
120x30 - 120x20 - 120x15 cm



Floor: Rovere Briccola
120x20 - 120x15 cm

ROVERE NOCE









Floor: Rovere Noce
120x30 - 120x20 - 120x15 cm

ROVERE COUNTRY







Floor: Rovere Country
120x30 - 120x20 - 120x15 cm



Floor: Rovere Country
120x20 - 120x15 cm

ROVERE IMPERO







Floor: Rovere Impero
120x20 - 120x15 cm



ROVERE REALE







Floor: Rovere Reale
120x30 - 120x20 - 120x15 cm



Floor: Rovere Reale
120x30 - 120x20 - 120x15 cm

90x11 cm
36"x4½"

90x15 cm
36"x6"

90x22,5 cm
36"x9"

ROVERE GRIGIO

ROVERE BIANCO

ROVERE NATURALE

ROVERE BIONDO

ROVERE 90

ROVERE CILIEGIO

ROVERE MOKA

ROVERE ANTICO

ROVERE ABBAZIA

ROVERE NERO

10_{mm} THICKNESS
3 SIZE
9 COLORS
ANTIQUED FINISH

ROVERE GRIGIO





ROVERE BIANCO







Floor: Rovere Bianco
90x11 cm



Floor: Rovere Bianco
90x11 cm

ROVERE NATURALE





ROVERE BIONDO





ROVERE CILIEGIO







Floor: Rovere Ciliegio
90x11 cm



Floor: Rovere Ciliegio
90x22,5 - 90x15 - 90x11 cm

ROVERE MOKA







Floor: Rovere Moka
90x11 cm



Floor: Rovere Moka
90x11 cm

ROVERE ANTICO





Floor: Rovere Antico
90x11 cm



Floor: Rovere Antico
90x22,5 cm

ROVERE ABBAZZIA









Floor: Rovere Abbazia
90x22,5 - 90x15 - 90x11 cm

ROVERE NERO





WOOD RAW

Crudo ed essenziale sono gli aggettivi migliori per descrivere la nuova collezione WoodRaw di Ariostea. Le tracce vissute di questi legni dalla forte personalità si declinano in 5 tonalità differenti per una moderna esperienza dell'abitare.

Raw and essential are the best attribute match to describe the new WoodRaw collection by Ariostea. The enduring signs of these distinguished woods are characterizing 5 different tiles tones for a modern living experience.

Roh und essentiell sind die besten Adjektive um die neue Kollektion WoodRaw von Ariostea zu beschreiben. Die spuren der Lebenserfahrung dieser Hölzer mit starker Persönlichkeit variieren in 5 verschiedene Farben für ein modernes Wohnerlebnis.

Brut et essentiel sont les meilleurs adjectifs pour décrire la nouvelle collection WoodRaw de Ariostea. Les traces visibles sur ces bois à la forte personnalité se déclinent en 5 teintes différentes pour une expérience moderne de l'habitat.

8_{mm} THICKNESS
5 COLORS
1 SIZE
ANTIQUED FINISH

120x20 cm
48"x8"



ASH



ARTIC



POWDER



BOARD



RUST

ASH







Floor: Ash
120x20 cm



Floor: Ash
120x20 cm

ARTIC







Wall: Artic
120x20 cm



POWDER









Floor: Powder
120x20 cm

BOARD







Floor: Board
120x20 cm



RUST







Floor: Rust
120x20 cm





Floor: Rust
120x20 cm



Floor: Rust
120x20 cm



THE IDEAL SOLUTION FOR OUTDOOR PAVING

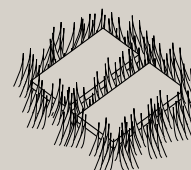
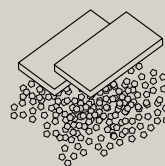
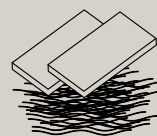
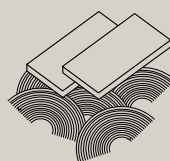
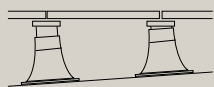
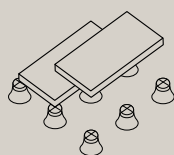

CM2 è la soluzione ideale per la pavimentazione in esterno, con destinazione d'uso sia pubblico che privato. Facile da posare, estremamente agevole per l'ispezione di eventuali impianti e riposizionabile rapidamente in caso di variazioni di posa o di modificazioni del sottofondo.

CM2 possiede spessore e massa atti a garantire le prestazioni di resistenza meccanica e longevità richieste dalle diverse situazioni di rivestimento outdoor:

- + PAVIMENTAZIONE SOPRAELEVATA SU SUPPORTI REGOLABILI E FISSI
- + PAVIMENTAZIONE CARRABILE CON POSA TRADIZIONALE SU MASSETTO
- + POSA A SECCO SU GHIAIA, SABBIA ED ERBA

CM2 ist die ideale Lösung für die Bodenabdeckung im Außenbereich, und zwar sowohl für die private wie auch die öffentliche Benützung. Einfach zu verlegen, kann dieses Produkt im Falle von Revisionen allfälliger Installationen leicht bewegt und bei Veränderungen der Abdeckung oder des Untergrunds rasch verlegt werden.

CM2 verfügt über eine Stärke und Masse, die eine für die Außenabdeckung geeignete mechanische Widerstandsfähigkeit und Langlebigkeit garantieren:

- + BODENBELÄGE, DIE AUF EINSTELLBAREN ODER FIXEN STÜTZEN VERLEGT WERDEN
- + BEFAHRBARE BODENBELÄGE, DIE AUF EINER TRADITIONELLEN ZEMENTUNTERLAGE ANGEBRACHT WERDEN
- + TROCKENVERLEGUNG AUF KIES, SAND ODER GRAS

CM2 is the ideal solution for outdoor paving, designed for both public and private use.

Easy to install, very easy to inspect any utilities, and easy to reposition in the event of changes to the installation or modifications to the substrate.

CM2 has dimensions and mass such as to guarantee the mechanical resistance and longevity demanded by the diverse requirements of outdoor paving:

- + RAISED PAVING ON ADJUSTABLE OR FIXED SUPPORTS
- + DRIVEWAY PAVING WITH TRADITIONAL INSTALLATION ON SCREED
- + DRY INSTALLATION ON GRAVEL, SAND OR GRASS

CM2 est la solution idéale pour les sols extérieurs, à usage public et privé. Facile à installer, extrêmement maniable pour l'inspection d'éventuelles installations, les dalles peuvent être repositionnées rapidement en cas de variations de pose ou de modifications du support.

La masse et l'épaisseur de CM2 peuvent assurer les prestations de résistance mécanique et de longévité que les différentes situations revêtement demandent:

- + SOL SURÉLEVÉ SUR SUPPORT RÉGLABLES ET FIXES
- + SOL CARROSSABLE AVEC UNE POSE TRADITIONNELLE SUR CHAPE DE CIMENT
- + POSE À SEC SUR GRAVIER, SABLE ET HERBE



ROVERE CENERE

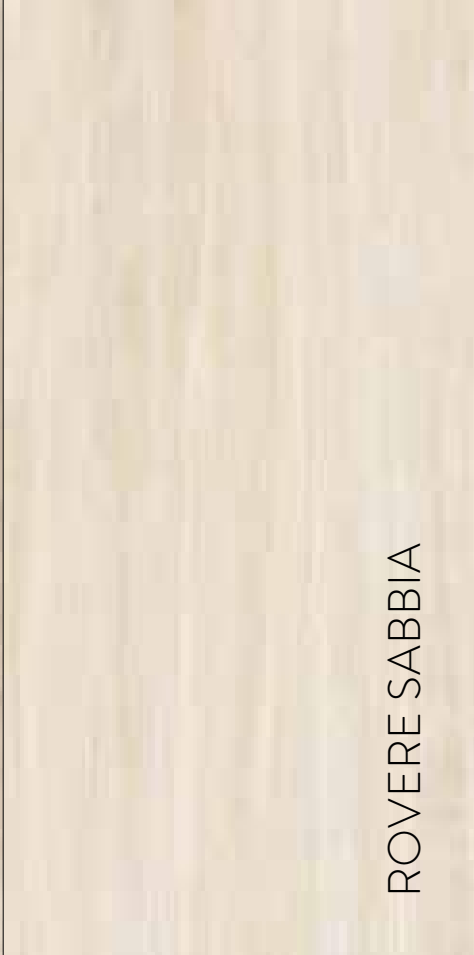

ROVERE SABBIA



ROVERE GRIGIO

120x60
48"x 24"

120x30
48"x 12"



ROVERE BRICCOLA



ROVERE IMPERO



ROVERE TUNDRA

APPLICAZIONI DEL CM2

APPLICATIONS OF CM2

ANWENDUNGEN VON CM2

LES APPLICATIONS DE CM2

- + **PAVIMENTAZIONE SOPRAELEVATA SU SUPPORTI REGOLABILI E FISSI**
- + RAISED PAVING ON ADJUSTABLE OR FIXED SUPPORTS
- + BODENABDECKUNGEN AUF EINSTELLBAREN ODER FIXEN STÜTZEN
- + SOL SURÉLEVÉ SUR SUPPORT RÉGLABLES ET FIXES

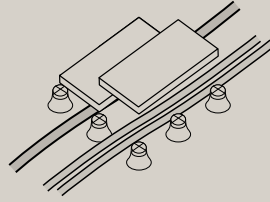

- + **PAVIMENTAZIONE CARRABILE CON POSA TRADIZIONALE SU MASSETTO**
- + DRIVEWAY PAVING ON TRADITIONAL SCREED
- + BEFAHRBARE BODENABDECKUNG, DIE AUF EINER TRADITIONELLEN ZEMENTUNTERLAGE ANGEBRACHT WIRD
- + SOL CARROSSABLE AVEC UNE INSTALLATION TRADITIONNELLE SUR CHAPE

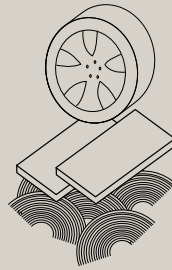

- + **POSA A SECCO SU GHIAIA**
- + DRY INSTALLATION ON GRAVEL
- + TROCKENVERLEGUNG AUF KIES
- + POSE À SEC SUR GRAVIER

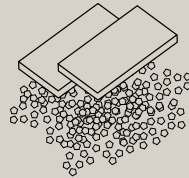

- + **POSA A SECCO SU SABBIA**
- + DRY INSTALLATION ON SAND
- + TROCKENVERLEGUNG AUF SAND
- + POSE À SEC SUR SABLE

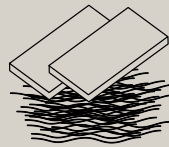

- + **POSA A SECCO SU ERBA**
- + DRY INSTALLATION ON GRASS
- + TROCKENVERLEGUNG AUF GRAS
- + POSE À SEC SUR HERBE

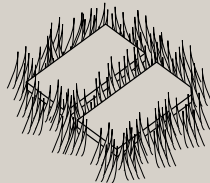



VANTAGGI DEL CM2

ADVANTAGES OF CM2

VORTEILE VON CM2

LES AVANTAGES DE CM2

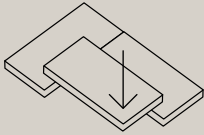

- + Facile da posare anche senza collanti e stucchi;
- + Easy to install even without adhesives or filler;
- + Einfach zu verlegen, auch ohne Klebstoffe oder Mörtel;
- + Facile à installer sans colles ni joints.

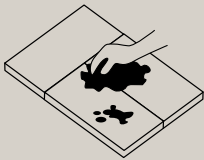

- + Facile da pulire perché non si utilizzano collanti e stucchi;
- + Easy to clean due to the lack of adhesives and filler;
- + Einfach zu reinigen, da keine Klebstoffe oder Mörtel verwendet werden;
- + Facile à nettoyer parce que vous n'utilisez ni colles ni joints.

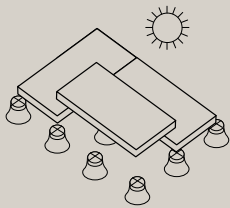

- + Ideale per pavimentazioni in esterno, anche sopraelevate;
- + Ideal for paving outdoor installations, including raised paving;
- + Ideal für Aussenabdeckungen, auch für überlagerte Konstruktionen;
- + Idéal pour les pavages extérieurs, même surélevés.

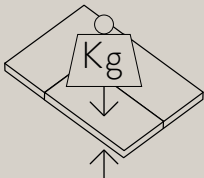

- + Resistente ai carichi di rottura;
- + High tensile strength;
- + Widerstandsfähig gegen Reißfestigkeit;
- + Résistant aux charges de rupture.

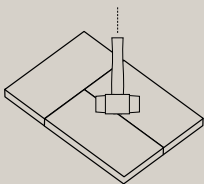

- + Resistente alle sollecitazioni;
- + Stress-resistant;
- + Widerstandsfähig gegen Beanspruchung;
- + Résistant aux sollicitations.

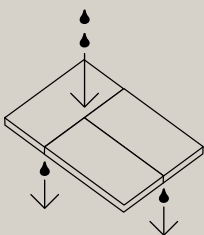

- + Drenante, facilita il deflusso delle acque di meteoriche ed evita ristagni potenzialmente dannosi;
- + Good drainage, facilitates the flow of water and rainfall, eliminating harmful stagnation;
- + Sezernierend, erleichtert den Abfluss bei Niederschlag und verhindert potentiell schädlichen Rückstau;
- + Drainant, il facilite la circulation des eaux de pluie et évite des stagnations potentiellement dangereuses;

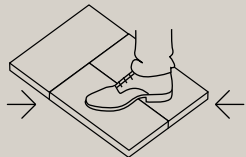

- + Antiscivolo (R11 - A+B)
- + Antislip (R11 - A+B)
- + Rutschfest (R11 - A+B)
- + Antidérapant (R11 - A+B)

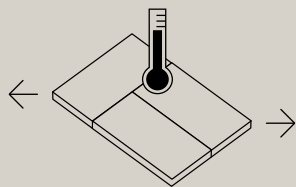

- + Resistente alla dilatazione termica;
- + Highly resistant to changes in temperature;
- + Sehr widerstandsfähig gegen Wärmeausdehnung;
- + Résiste à la dilatation thermique.

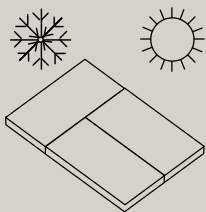

- + Resistente agli agenti atmosferici;
- + Weather resistant;
- + Widerstandsfähig gegen Klimaeinflüsse;
- + Résistant aux agents atmosphériques.



- + Antigelivo ed ignifugo;
- + Frost and fire-resistant;
- + Frost-und feuersicher;
- + Résistant au gel et ignifugé.

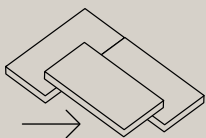

- + Removibile e riutilizzabile;
- + Removable and reusable;
- + Auswechselbar und wiederverwendbar;
- + Amovible et réutilisable.

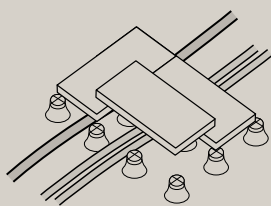

- + Ispezionabile e funzionale, favorisce il passaggio e la manutenzione di impianti di cablaggi e tubazioni;
- + Easily inspected and functional, allows installation and maintenance of cabling and pipework;
- + Überprüfbar und funktionell; ermöglicht die Verlegung und den Unterhalt von Kabelleitungen und Rohrleitungen;
- + Grâce à une inspection facile et fonctionnelle, les dalles favorisent le passage et le maintien des installations de câbles et de tuyaux.

DESCRIZIONE Active Clean Air & Antibacterial Ceramic™ è una nuova finitura ottenuta attraverso una metodologia basata su un trattamento innovativo al biossido di titanio in forma micrometrica, che agisce da fotocatalizzatore, effettuato sulle lastre in gres porcellanato a temperatura elevata.

PROPRIETA' L'applicazione di Active Clean Air & Antibacterial Ceramic™ concretizza le tre qualità del materiale, attivando tre azioni molto importanti che sono: antinquinante, antibatterica, autopulente (solo per pareti esterne).

UTILIZZO Le eccellenti qualità fisico chimiche di Active Clean Air & Antibacterial Ceramic™ lo rendono ideale per i seguenti impieghi: rivestimenti esterni di edifici, rivestimenti interni, rivestimenti nel settore: ospedaliero e sanitario, scolastico, wellness, ambiti in cui l'igiene è requisito indispensabile.

VANTAGGI In presenza di luce e aria si attiva un forte processo ossidativo che porta alla decomposizione di determinate sostanze organiche ed inorganiche quando queste vengano a contatto con la superficie di Active Clean Air & Antibacterial Ceramic™. I vantaggi che si possono trarre dall'utilizzo di Active sono: mantenimento e conservazione delle caratteristiche estetiche e, al contempo, la possibilità di avere superfici che repellono lo sporco, abbattimento di diversi inquinanti, purificazione dell'aria, eliminazione di batteri.

ACTIVE™

CLEAN AIR & ANTIBACTERIAL CERAMIC

BESCHREIBUNG Active Clean Air & Antibacterial Ceramic™ ist eine neue Ausführung, die auf einer innovativen Behandlung mit als Fotokatalysator wirkendem Titanbioxyd in mikrometrischer Form basiert. Die Behandlung der Feinsteinzeugplatten erfolgt bei hoher Temperatur.

EIGENSCHAFTEN Die Anwendung von Active Clean Air & Antibacterial Ceramic™ konkretisiert die drei Qualitäten des Materials durch: umweltschützende Wirkung, antibakterielle Wirkung, selbstreinigende Wirkung (nur für Aussenfassaden).

VERWENDUNG Durch die vortrefflichen physikalisch-chemischen Eigenschaften von Active Clean Air & Antibacterial Ceramic™ eignet sich dieses Produkt vortrefflich für den Einsatz in den folgenden Bereichen: Außenverkleidungen von Gebäuden, Innenverkleidungen, Verkleidungen auf folgenden Gebieten: Spitäler/ Krankenhäuser und Sanitär, Schulen, Wellness, Umgebungen, in denen Hygiene absolut erforderlich ist.

VORTEILE Unter der Einwirkung von Licht tritt ein intensiver Oxydationsprozess ein, der zur Zersetzung gewisser organischer und nicht organischer Stoffe führt, wenn diese mit der Oberfläche des Active Clean Air & Antibacterial Ceramic™ in Berührung kommen. Die Verwendung von Active bringt folgende Vorteile: Aufrechterhaltung unveränderter ästhetischer Eigenschaften und gleichzeitig die Möglichkeit, über schmutzabstossende Oberflächen zu verfügen, Vernichtung verschiedener Schadstoffe, Reinigung der Luft, Beseitigung der Bakterien.

DESCRIPTION Active Clean Air & Antibacterial Ceramic™ is a new finish obtained through a production methodology based on an innovative micrometric titanium dioxide process, which acts as a photocatalyst, carried on porcelain slabs at high temperature.

PROPERTIES Applying Active Clean Air & Antibacterial Ceramic™ brings out the three qualities of the material, activating three very important actions that are: anti-pollution, antibacterial, self-cleaning (only for external walls).

USE The excellent physical-chemical characteristics of Active Clean Air & Antibacterial Ceramic™ make it ideal for the following applications: exterior cladding of buildings, interior, walls in following areas: Hospitals and health centres, Schools, Wellness centres, Environments where hygiene is an essential requirement.

ADVANTAGES In presence of light and air, a strong oxidation is activated by Active Clean Air & Antibacterial Ceramic™, that leads to the decomposition of particular organic and inorganic substances, when they come into contact with the surface of Active. The benefits achieved with the use of Active are: maintenance and preservation of aesthetic characteristics and, meanwhile, the possibility to have surfaces repelling dirt, abatement of different pollutants, air purification, elimination of bacteria.



DESCRIPTION Active Clean Air & Antibacterial Ceramic™ es une nouvelle finition. La technique de fabrication s'appuie sur un traitement révolutionnaire qui utilise le dioxyde de titane à l'échelle micrométrique – le photocatalyseur – sur les dalles en gres cérame, à hautes températures.

PROPRIÉTÉS Active Clean Air & Antibacterial Ceramic™ apporte les trois qualités matérielles via trois actions très importantes: antipolluante, antibactérienne, autonettoyante (seulement pour murs extérieurs).

APPLICATION Grâce à ses extraordinaires qualités physicochimiques, Active Clean Air & Antibacterial Ceramic™ est recommandé pour les applications suivantes: revêtement des façades, revêtements intérieurs, revêtements dans le secteur: hospitalier et sanitaire, éducation nationale, wellness, lieux où l'hygiène est un critère indispensable.

AVANTAGES L'action combinée de la lumière et de l'air déclenche une oxydation intense qui entraîne le décomposition de certaines substances organiques et inorganiques, lorsqu'elles entrent en contact avec le surface Active Clean Air & Antibacterial Ceramic™. Les avantages d'Active sont: maintien et conservation des caractéristiques esthétiques et, en même temps, possibilité d'avoir des surfaces autonettoyantes, réduction de plusieurs polluants, purification de l'air, suppression des bactéries.



BE ACTIVE

BE a TREE!

www.active-ceramic.com

Il trattamento ACTIVE può indurre variazioni cromatiche e di brillantezza sui materiali, più sensibili sui colori scuri.

ACTIVE treatment can induce variations of colours and brightness on the material, more noticeable on dark colours.

Die ACTIVE Behandlung kann Farb- und Glanzabweichungen auf den Materialien zur Folge haben. Bei dunklen Farben sind diese leichter bemerkbar.

Le traitement ACTIVE peut induire de variations de couleur et de luminosité sur les matériaux, le plus sensible sur les couleurs foncées.



CODICI E FORMATI

CODES AND SIZES / ARTIKELNR. UND FORMATE / CODES ET FORMATS

FINITURA / FINISH / OBERFLÄCHENAUSFÜHRUNG / FINITION

AN: Anticato / Antiqued / Antik / Antique

SO: Soft

RETTIFICATO MONOCALIBRO / RECTIFIED SINGLE-CALIBRE /
REKTIFIZIERT EINKALIBRIG / RECTIFIÉ MONOCALIBRE

ULTRA WOOD

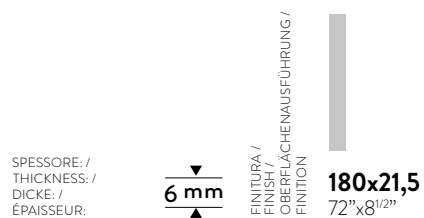

NOCE AMERICANO	SOFT	UW6S180493
NOCE CALCE	SOFT	UW6S180494
NOCE CHIARO	SOFT	UW6S180495
NOCE OSSIDATO	SOFT	UW6S180496
NOCE SCURO	SOFT	UW6S180497

INNOVATIVE SLABS LEGNI HIGH-TECH

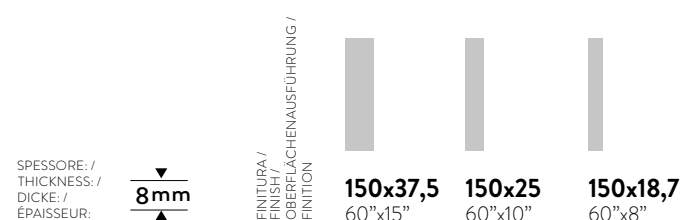

QUERCIA BIANCA	AN	PAR37448	PAR25448	PAR18448
QUERCIA PETRAEA	AN	PAR37449	PAR25449	PAR18449
QUERCIA TROPICALE	AN	PAR37450	PAR25450	PAR18450
QUERCIA CANADESE	AN	PAR37482	PAR25482	PAR18482
QUERCIA SHABBY	AN	PAR37483	PAR25483	PAR18483

LEGNI HIGH-TECH

AN: Anticato / Antiqued / Antik / Antique SO: Soft

		SPESSORE: / THICKNESS: / DICKE: / ÉPAISSEUR: 10mm				FINITURA / FINISH / OBERFLÄCHENAUFÜHRUNG / FINITION		
		120x30 48"x12"	120x20 48"x8"	120x15 48"x6"	60x10 24"x4"	90x22,5 36"x9"	90x15 36"x6"	90x11 36"x4 ^{1/2} "
ROVERE ABBAZIA	AN	-	-	-	-	PAR22364	PAR15364	PAR11364
ROVERE ANTICO	AN	-	-	-	-	PAR22334	PAR15334	PAR11334
ROVERE BIANCO	AN	-	-	-	-	PAR22342	PAR15342	PAR11342
ROVERE BIANCO	ACTIVE	AN	-	-	-	PAR22342AC	PAR15342AC	PAR11342AC
ROVERE BIONDO	AN	-	-	-	-	PAR22322	PAR15322	PAR11322
ROVERE BIONDO	ACTIVE	AN	-	-	-	PAR22322AC	PAR15322AC	PAR11322AC
ROVERE BRICCOLA	AN	PAR30425	PAR20425	PAR115425	PAR10425	-	-	-
ROVERE CENERE	AN	PAR30397	PAR20397	PAR115397	PAR10397	-	-	-
ROVERE CILIEGIO	AN	-	-	-	-	PAR22336	PAR15336	PAR11336
ROVERE CORDA	AN	PAR30379	PAR20379	PAR115379	PAR10379	-	-	-
ROVERE CORDA	ACTIVE	AN	PAR30379AC	PAR20379AC	PAR115379AC	-	-	-
ROVERE COUNTRY	AN	PAR30426	PAR20426	PAR115426	PAR10426	-	-	-
ROVERE DECAPÈ	AN	PAR30389	PAR20389	PAR115389	PAR10389	-	-	-
ROVERE GRIGIO	AN	-	-	-	-	PAR22335	PAR15335	PAR11335
ROVERE GRIGIO	ACTIVE	AN	-	-	-	PAR22335AC	PAR15335AC	PAR11335AC
ROVERE IMPERO	AN	PAR30386	PAR20386	PAR115386	PAR10386	-	-	-
ROVERE MOKA	AN	-	-	-	-	PAR22323	PAR15323	PAR11323
ROVERE MOKA	ACTIVE	AN	-	-	-	PAR22323AC	PAR15323AC	PAR11323AC
ROVERE NATURALE	AN	-	-	-	-	PAR22365	PAR15365	PAR11365
ROVERE NATURALE	ACTIVE	AN	-	-	-	PAR22365AC	PAR15365AC	PAR11365AC
ROVERE NERO	AN	-	-	-	-	PAR22320	PAR15320	PAR11320
ROVERE NOCE	AN	PAR30395	PAR20395	PAR115395	PAR10395	-	-	-
ROVERE PROVENZALE	AN	PAR30424	PAR20424	PAR115424	PAR10424	-	-	-
ROVERE REALE	AN	PAR30387	PAR20387	PAR115387	PAR10387	-	-	-
ROVERE SABBIA	AN	PAR30396	PAR20396	PAR115396	PAR10396	-	-	-
ROVERE TUNDRA	AN	PAR30380	PAR20380	PAR115380	PAR10380	-	-	-

WOODDRAW

		SPESSORE: / THICKNESS: / DICKE: / ÉPAISSEUR: 8mm		FINITURA / FINISH / OBERFLÄCHENAUFÜHRUNG / FINITION	
		120x20 48"x8"			
ARTIC	AN	PAR20488			
ASH	AN	PAR20489			
BOARD	AN	PAR20490			
POWDER	AN	PAR20491			
RUST	AN	PAR20492			

CM2 ARIOSTEA HIGH-TECH

		SPESSORE: / THICKNESS: / DICKE: / ÉPAISSEUR: 20mm			FINITURA / FINISH / OBERFLÄCHENAUFÜHRUNG / FINITION		
		120x60 48"x24"	120x30 48"x12"				
ROVERE BRICCOLA	CM2	PMA612425	PMA30425				
ROVERE CENERE	CM2	PMA612397	PMA30397				
ROVERE GRIGIO	CM2	PMA612335	PMA30335				
ROVERE IMPERO	CM2	PMA612386	PMA30386				
ROVERE SABBIA	CM2	PMA612396	PMA30396				
ROVERE TUNDRA	CM2	PMA612380	PMA30380				

MOSAICI

MOSAICS / MOSAIKEN / MOSAÏQUES

LEGNI HIGH-TECH

CLASSIC
30X30 cm 12"x12"

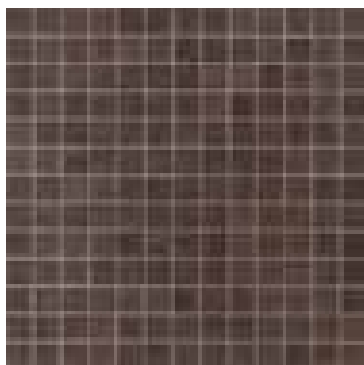

Disponibile in tutti colori della serie/
Available in all the colours of the collection/
Verfügbar in allen Farben der Serie/
Disponibile dans toutes les couleurs de la série /

DOMINO
30X30 cm 12"x12"



Disponibile in tutti colori della serie/
Available in all the colours of the collection/
Verfügbar in allen Farben der Serie/
Disponibile dans toutes les couleurs de la série /

MULTILAMA
30X15 cm 12"x6"

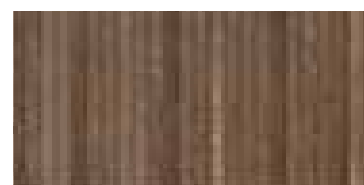

Disponibile in tutti colori della serie/
Available in all the colours of the collection/
Verfügbar in allen Farben der Serie/
Disponibile dans toutes les couleurs de la série /

MAXILAMA
90X22,5 cm 36"x9"



ROVERE ABBAZIA
ROVERE ANTICO
ROVERE BIANCO
ROVERE BIONDO
ROVERE CILIEGIO
ROVERE GRIGIO
ROVERE MOKA
ROVERE NATURALE
ROVERE NERO

PEZZI SPECIALI

TRIMS / FORMTEILE / PIÈCES SPÉCIALES

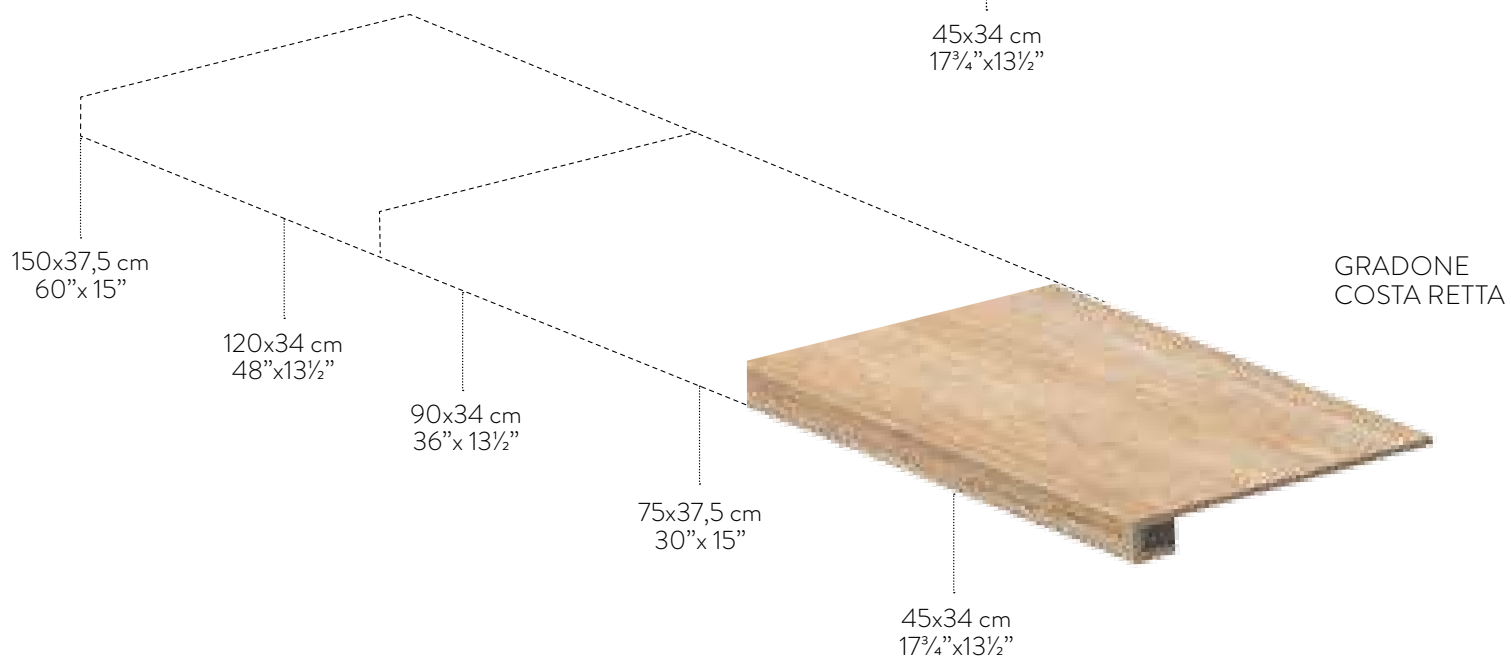
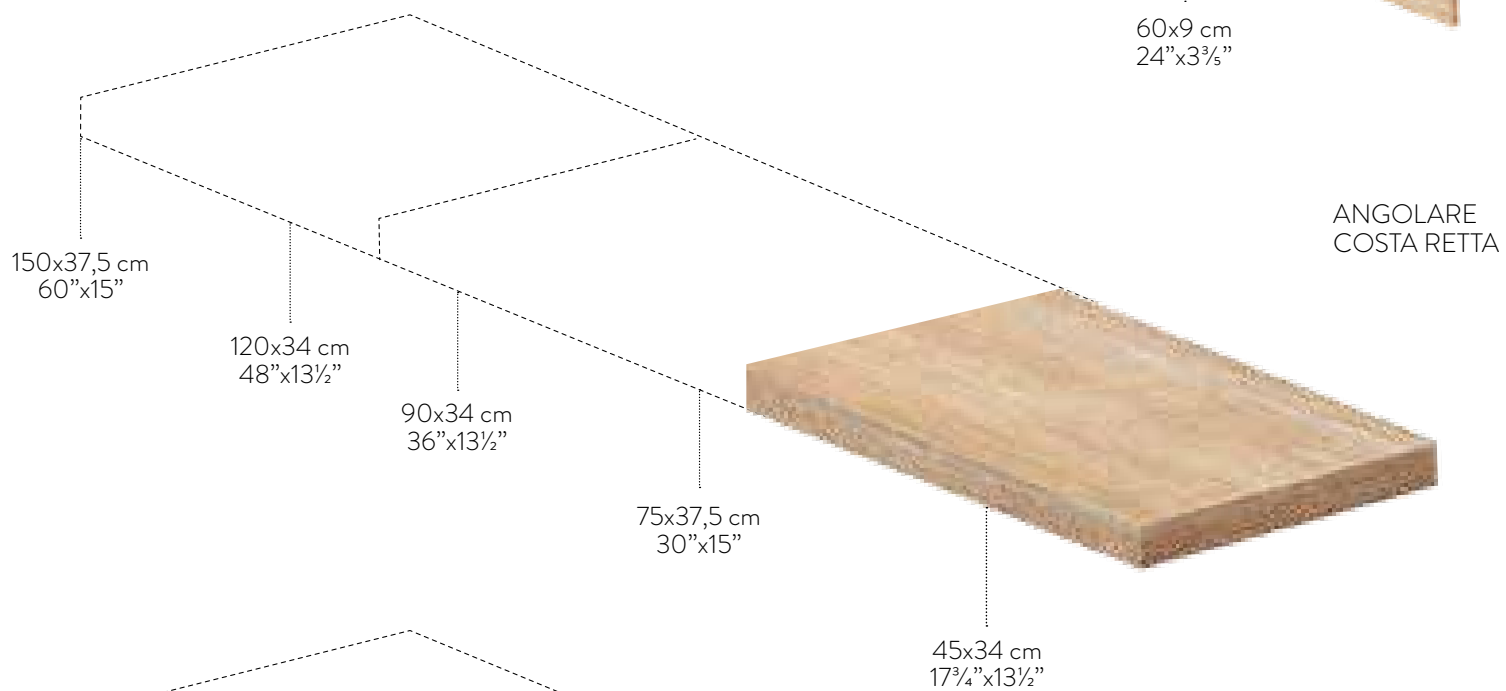
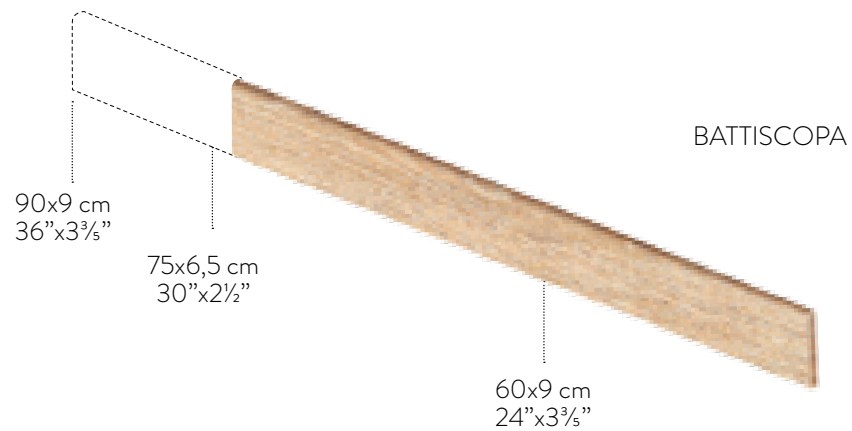

PEZZI SPECIALI

TRIMS / FORMTEILE / PIÈCES SPÉCIALES

AN: Anticato / Antiqued / Antik / Antique

LEGNI HIGH-TECH

PEZZI SPECIALI
TRIMS /
FORMTEILE /
PIÈCES SPÉCIALES

FINITURA /
FINISH /
OBERFLÄCHENAUFÜHRUNG /
FINITION

BATTISCOPIA / BULLNOSE /
STEHSOCKEL / PLINTHE



90x9
36"x3^{3/5}"

60x9
24"x3^{3/5}"

GRADONE COSTA RETTA / COSTA RETTA STEP TREAD /
STUFE COSTA RETTA / NEZ DE MARCHE COSTA RETTA

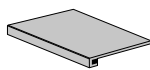

120x34
48"x13^{1/2}"

90x34
36"x13^{1/2}"

45x34
17^{3/4}"x13^{1/2}"

ANGOLARE COSTA RETTA / COSTA RETTA STEP TREAD CORNER /
ECKSTUFE COSTA RETTA / NEZ DE MARCHE COSTA RETTA AVEC ANGLE

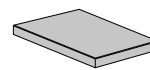

120x34
48"x13^{1/2}"

90x34
36"x13^{1/2}"

45x34
17^{3/4}"x13^{1/2}"

ROVERE ABBAZIA	AN	BA90364T	-
ROVERE ANTICO	AN	BA90334T	-
ROVERE BIANCO	AN	BA90342T	-
ROVERE BIONDO	AN	BA90322T	-
ROVERE BRICCOLA	AN	-	BA9425T
ROVERE CENERE	AN	-	BA9397T
ROVERE CILIEGIO	AN	BA90336T	-
ROVERE CORDA	AN	-	BA9379T
ROVERE COUNTRY	AN	-	BA9426T
ROVERE DECAPÈ	AN	-	BA9389T
ROVERE GRIGIO	AN	BA90335T	-
ROVERE IMPERO	AN	-	BA9386T
ROVERE MOKA	AN	BA90323T	-
ROVERE NATURALE	AN	BA90365T	-
ROVERE NERO	AN	BA90320T	-
ROVERE NOCE	AN	-	BA9395T
ROVERE PROVENZALE	AN	-	BA9424T
ROVERE REALE	AN	-	BA9387T
ROVERE SABBIA	AN	-	BA9396T
ROVERE TUNDRA	AN	-	BA9380T

-	PGRA90364	PGRA45364
-	PGRA90334	PGRA45334
-	PGRA90342	PGRA45342
-	PGRA90322	PGRA45322
PGRA12425	-	-
PGRA12397	-	-
-	PGRA90336	PGRA45336
PGRA12379	-	-
PGRA12426	-	-
PGRA12389	-	-
-	PGRA90335	PGRA45335
PGRA12386	-	-
-	PGRA90323	PGRA45323
-	PGRA90365	PGRA45365
-	PGRA90320	PGRA45320
PGRA12395	-	-
PGRA12424	-	-
PGRA12387	-	-
PGRA12396	-	-
PGRA12380	-	-

-	PRAA90364	PRAA45364
-	PRAA90334	PRAA45334
-	PRAA90342	PRAA45342
-	PRAA90322	PRAA45322
PRAA12425	-	-
PRAA12397	-	-
-	PRAA90336	PRAA45336
PRAA12379	-	-
PRAA12426	-	-
PRAA12389	-	-
-	PRAA90335	PRAA45335
PRAA12386	-	-
-	PRAA90323	PRAA45323
-	PRAA90365	PRAA45365
-	PRAA90320	PRAA45320
PRAA12395	-	-
PRAA12424	-	-
PRAA12387	-	-
PRAA12396	-	-
PRAA12380	-	-

INNOVATIVE SLABS LEGNI HIGH-TECH

PEZZI SPECIALI
TRIMS /
FORMTEILE /
PIÈCES SPÉCIALES

FINITURA /
FINISH /
OBERFLÄCHENAUFÜHRUNG /
FINITION

BATTISCOPIA / BULLNOSE /
STEHSOCKEL / PLINTHE



75x6,5
30"x2^{1/2}"

GRADONE COSTA RETTA / COSTA RETTA STEP TREAD /
STUFE COSTA RETTA / NEZ DE MARCHE COSTA RETTA

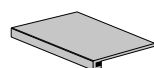

150x37,5
60"x15"

75x37,5
30"x15"

ANGOLARE COSTA RETTA / COSTA RETTA STEP TREAD CORNER /
ECKSTUFE COSTA RETTA / NEZ DE MARCHE COSTA RETTA AVEC ANGLE

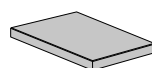

150x37,5
60"x15"

75x37,5
30"x15"

QUERCIA BIANCA	AN	BA75448T	PGRA150448	PGRA75448	PRAA150448	PRAA75448
QUERCIA PETRAEA	AN	BA75449T	PGRA150449	PGRA75449	PRAA150449	PRAA75449
QUERCIA TROPICALE	AN	BA75450T	PGRA150450	PGRA75450	PRAA150450	PRAA75450
QUERCIA CANADESE	AN	BA75482T	PGRA150482	PGRA75482	PRAA150482	PRAA75482
QUERCIA SHABBY	AN	BA75483T	PGRA150483	PGRA75483	PRAA150483	PRAA75483

LEGNI HIGH-TECH

MOSAICI
MOSAICS /
MOSAIKEN /
MOSAIQUES

FINITURA /
FINISH /
OBERFLÄCHENAUFÜHRUNG /
FINITION



30x15
12"x6"



30x30
12"x12"



30x30
12"x12"





90x22,5
36"x9"

ROVERE ABBAZIA	AN	LAM15364	MC364	DOM364	LAM22364
ROVERE ANTICO	AN	LAM15334	MC334	DOM334	LAM22334
ROVERE BIANCO	AN	LAM15342	MC342	DOM342	LAM22342
ROVERE BIONDO	AN	LAM15322	MC322	DOM322	LAM22322
ROVERE BRICCOLA	AN	LAM15425	MC425	DOM425	-
ROVERE CENERE	AN	LAM15397	MC397	DOM397	-
ROVERE CILIEGIO	AN	LAM15336	MC336	DOM336	LAM22336
ROVERE CORDA	AN	LAM15379	MC379	DOM379	-
ROVERE COUNTRY	AN	LAM15426	MC426	DOM426	-
ROVERE DECAPÈ	AN	LAM15389	MC389	DOM389	-
ROVERE GRIGIO	AN	LAM15335	MC335	DOM335	LAM22335
ROVERE IMPERO	AN	LAM15386	MC386	DOM386	-
ROVERE MOKA	AN	LAM15323	MC323	DOM323	LAM22323
ROVERE NATURALE	AN	LAM15365	MC365	DOM365	LAM22365
ROVERE NERO	AN	LAM15320	MC320	DOM320	LAM22320
ROVERE NOCE	AN	LAM15395	MC395	DOM395	-
ROVERE PROVENZALE	AN	LAM15424	MC424	DOM424	-
ROVERE REALE	AN	LAM15387	MC387	DOM387	-
ROVERE SABBIA	AN	LAM15396	MC396	DOM396	-
ROVERE TUNDRA	AN	LAM15380	MC380	DOM380	-

IMBALLAGGI E PESI

PACKING AND WEIGHTS / VERPACKUNG UND GEWICHT / EMBALLAGES ET POIDS

AN: Anticato / Antiqued / Antik / Antique
SO: Soft

FORMATI E SPESSORI/ SIZES AND THICKNESS/ FORMATE UND STÄRKE/ FORMATS ET ÉPAISSEUR	1800 x 215 mm 6 mm	1500 x 375 mm 8 mm	1500 x 250 mm 8 mm	1500 x 187 mm 8 mm	1200 x 600 mm 20 mm	1200 x 300 mm 10 mm	1200 x 300 mm 20 mm	1200 x 200 mm 10 mm	1200 x 200 mm 8 mm	1200 x 150 mm 10 mm
Collezione / Collection Kollektion / Collection	Ultra Wood	Innovative slabs Legni high-tech	Innovative slabs Legni high-tech	Innovative slabs Legni high-tech	Legni high-tech	Legni high-tech	Legni high-tech	Legni high-tech	Woodraw	Legni high-tech
						ACTIVE		ACTIVE		ACTIVE
Finitura / Finish Oberflächenführung / Finition	SO	AN	AN	AN	AN	AN	AN	AN	AN	AN
Pezzi scatola / Pieces box Stücke karton / Pièces boîte	4	2	3	4	1	3	2	4	6	6
Mq. Scatola / Sq. Mt. Box Qm. Karton / m ² boîte	1,548	1,125	1,125	1,125	0,72	1,08	0,72	0,96	1,44	1,08
Peso scatola / Weight box Gewicht karton / Poids boîte	21,78	20,835	20,835	20,835	32,12	24,17	32,12	21,485	24,78	24,17
Peso mq. / Sq. Mt. Weight Qm. Gewicht / Poids m ²	14,07	18,52	18,52	18,52	44,60	22,38	44,60	22,38	17,21	22,38
Scatole pallet / Box pallet Karton palette / Boîte palette	35	40	39	40	25	32	24	36	32	36
Mq. Pallet / Sq. Mt. Pallet Qm. Palette / m ² palette	54,18	45,00	43,88	45,00	18,00	34,56	17,28	34,56	46,08	38,88
Peso pallet / Weight pallet Gewicht palette / Poids palette	760,00	835	820	835	810	768,66	780	768,06	800	865

FORMATI E SPESSORI/ SIZES AND THICKNESS/ FORMATE UND STÄRKE/ FORMATS ET ÉPAISSEUR	900x 225 mm 10 mm	900x 150 mm 10 mm	900x 110 mm 10 mm	600x 100 mm 10 mm
Collezione / Collection Kollektion / Collection	Legni high-tech	Legni high-tech	Legni high-tech	Legni high-tech
	ACTIVE	ACTIVE	ACTIVE	
Finitura / Finish Oberflächenführung / Finition	AN	AN	AN	AN
Pezzi scatola / Pieces box Stücke karton / Pièces boîte	6	9	11	15
Mq. Scatola / Sq. Mt. Box Qm. Karton / m ² boîte	1,215	1,215	1,089	0,9
Peso scatola / Weight box Gewicht karton / Poids boîte	27,24	27,24	24,415	19,62
Peso mq. / Sq. Mt. Weight Qm. Gewicht / Poids m ²	22,42	22,42	22,42	21,80
Scatole pallet / Box pallet Karton palette / Boîte palette	36	36	40	40
Mq. Pallet / Sq. Mt. Pallet Qm. Palette / m ² palette	43,74	43,74	43,56	36,00
Peso pallet / Weight pallet Gewicht palette / Poids palette	973,45	973,45	968,615	779

IMBALLAGGI E PESI

AN: Anticato / Antiqued / Antik / Antique

PACKING AND WEIGHTS / VERPACKUNG UND GEWICHT / EMBALLAGES ET POIDS

PEZZI SPECIALI TRIMS / FORMTEILE / PIÈCES SPÉCIALES

Gradone costa retta /
Costa retta step tread /
Stufe costa retta / Nez de
marche costa retta

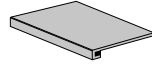

Angolare costa retta / Costa retta step
Tread corner / Eckstufe costa retta /
Nez de marche costa retta avec angle

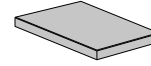

FORMATI E SPESSORI/
SIZES AND THICKNESS/
FORMATE UND STÄRKE/
FORMATS ET ÉPAISSEUR

**1500 x
375 mm
8 mm**

**1200 x
340 mm
10 mm**

**900 x
340 mm
10 mm**

**750 x
375 mm
8 mm**

**450 x
340 mm
10 mm**

**1500 x
375 mm
8 mm**

**1200 x
340 mm
10 mm**

**900 x
340 mm
10 mm**

**750 x
375 mm
8 mm**

**450 x
340 mm
10 mm**

Collezione / Collection
Kollektion / Collection

Innovative
slabs Legni
high-tech

Legni
high-tech

Legni
high-tech

Innovative
slabs Legni
high-tech

Legni
high-tech

Innovative
Slabs Legni
high-tech

Legni
high-tech

Legni
high-tech

Innovative
Slabs Legni
high-tech

Legni
high-tech

Finitura / Finish
Oberflächenausführung / Finition

AN

AN

AN

AN

AN

AN

AN

AN

AN

AN

Pezzi scatola / Pieces box
Stücke karton / Pièces boîte

1

1

1

2

4

1

1

1

1

2

Mq. Scatola / Sq. Mt. Box
Qm. Karton / m² boîte

**1,50
Lin. mt**

**1,20
Lin. mt**

**0,9
Lin. mt**

**1,50
Lin. mt**

**1,80
Lin. mt**

**1,50
Lin. mt**

**1,20
Lin. mt**

**0,90
Lin. mt**

**0,75
Lin. mt**

**0,90
Lin. mt**

Peso scatola / Weight box
Gewicht karton / Poids boîte

12,00

12,40

9,30

12,00

18,80

12,00

13,70

9,30

12,20

10,40

Battiscopa / Bullnose /
Stehssockel / Plinthe



FORMATI E SPESSORI/
SIZES AND THICKNESS/
FORMATE UND STÄRKE/
FORMATS ET ÉPAISSEUR

**900 x
90 mm
10 mm**

**750 x
65 mm
8 mm**

**600 x
90 mm
10 mm**

Collezione / Collection
Kollektion / Collection

Legni
high-tech

Innovative
Slabs
Legni
high-tech

Legni
high-tech

Finitura / Finish
Oberflächenausführung / Finition

AN

AN

AN

Pezzi scatola / Pieces box
Stücke karton / Pièces boîte

6

10

10

Mq. Scatola / Sq. Mt. Box
Qm. Karton / m² boîte

**5,4
Lin. mt**

**7,50
Lin. mt**

**6,0
Lin. mt**

Peso scatola / Weight box
Gewicht karton / Poids boîte

12,54

9,10

12,00

SOLUZIONI DI POSA

LAYING SCHEMES / VERLEGUNGS SCHEMAS / PROPOSITIONS DE POSE

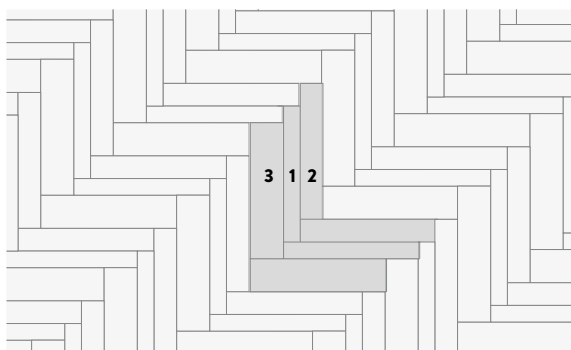

SPINA 3

1 - 90x11 ant. 22,90%	1 - 120x15 ant. 23,10%
2 - 90x15 ant. 30,80%	2 - 120x20 ant. 30,70%
3 - 90x22,5 ant. 46,30%	3 - 120x30 ant. 46,20%
<hr/>	
1 - 150x18,7 ant. 23,00%	
2 - 150x25 ant. 30,80%	
3 - 150x37,5 ant. 46,20%	

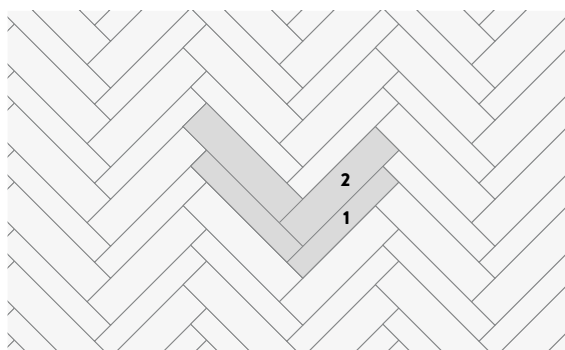

SPINA 2 DIAGONALE

1 - 90x15 ant. 40,00%	1 - 120x20 ant. 40,00%
2 - 90x22,5 ant. 60,00%	2 - 120x30 ant. 60,00%
<hr/>	
1 - 90x11 ant. 32,80%	1 - 120x15 ant. 33,40%
2 - 90x22,5 ant. 67,20%	2 - 120x30 ant. 66,60%
<hr/>	
1 - 90x11 ant. 42,30%	1 - 120x15 ant. 42,90%
2 - 90x15 ant. 57,70%	2 - 120x20 ant. 57,10%
<hr/>	
1 - 150x18,7 ant. 42,80%	
2 - 150x25 ant. 57,20%	
<hr/>	
1 - 150x18,7 ant. 33,30%	
2 - 150x37,5 ant. 66,70%	
<hr/>	
1 - 150x25 ant. 40,00%	
2 - 150x37,5 ant. 60,00%	

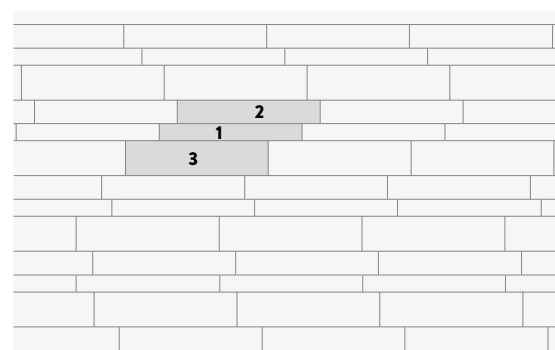

TOLDA 3

1 - 90x11 ant. 22,90%	1 - 120x15 ant. 23,10%
2 - 90x15 ant. 30,80%	2 - 120x20 ant. 30,70%
3 - 90x22,5 ant. 46,30%	3 - 120x30 ant. 46,20%
<hr/>	
1 - 150x18,7 ant. 23,00%	
2 - 150x25 ant. 30,80%	
3 - 150x37,5 ant. 46,20%	

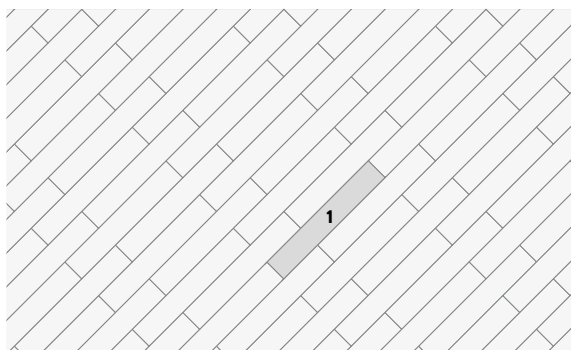

CASSERO DIAGONALE

1 - 90x15 ant. 100%	1 - 120x15 ant. 100%
<hr/>	
1 - 150x25 ant. 100%	1 - 180x21,5 ant. 100%

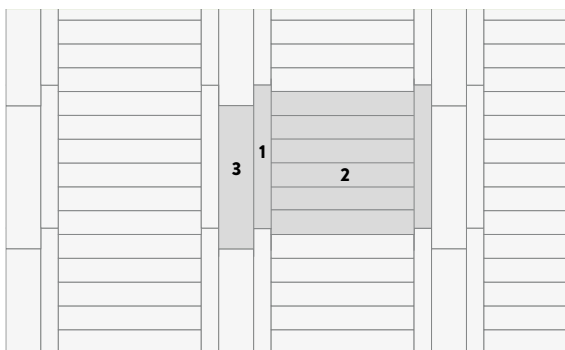

SPA 3

1 - 90x11 ant. 16,30%	1 - 120x15 ant. 16,70%
2 - 90x15 ant. 66,90%	2 - 120x20 ant. 66,60%
3 - 90x22,5 ant. 16,80%	3 - 120x30 ant. 16,70%

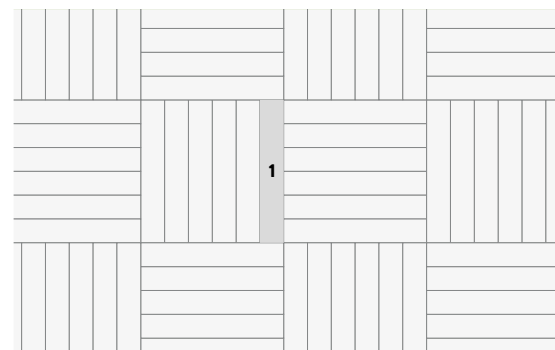

GARDEN

1 - 90x15 ant. 100% *	1 - 120x20 ant. 100% *
-----------------------	------------------------

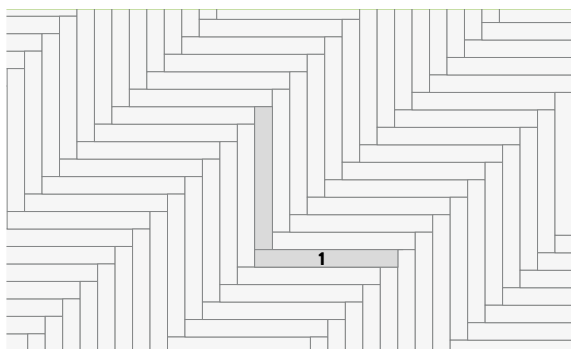

SPINA 1

1 - 90x11 ant. 100%	1 - 120x15 ant. 100%
	1 - 120x20 ant. 100%
<hr/>	
1 - 150x18,7 ant. 100%	1 - 180x21,5 ant. 100%
1 - 150x25 ant. 100%	

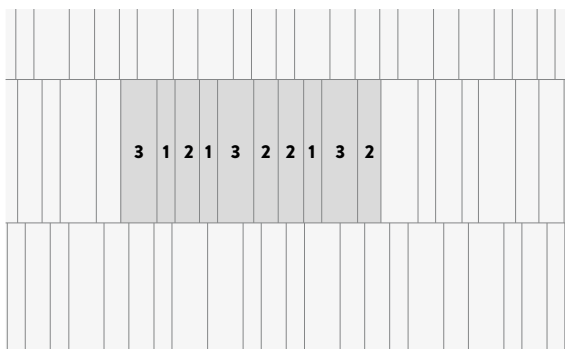

FRANCESE

1 - 90x11 ant. 20,70%	1 - 120x15 ant. 24,20%
2 - 90x15 ant. 37,20%	2 - 120x20 ant. 35,70%
3 - 90x22,5 ant. 42,10%	3 - 120x30 ant. 40,10%
<hr/>	
1 - 150x18,7 ant. 20,90%	
2 - 150x25 ant. 37,20%	
3 - 150x37,5 ant. 41,90%	













* Posare con una fuga di 2 mm /
Install the material with 2 mm of joint /
Legen das Material mit 2 mm der Fuge an /
Poser le matériel avec un joint de 2 mm.

CARATTERISTICHE TECNICHE

TECHNICAL FEATURES / TECHNISCHE EIGENSCHAFTEN / CARACTÉRISTIQUES TECHNIQUES

CLASSIFICAZIONE SECONDO LE NORME CEN E ISO GRUPPO B1a-UGL EN 14411 ALL.G E ISO 13006 ALL.G / CLASSIFICATION IN ACCORDANCE WITH CEN AND ISO STANDARDS B1a-UGL EN 14411 ENCLOSED G AND ISO 13006 ENCL. G / KLASSIFIZIERUNG GEMÄß CEN UND ISO NORMEN GRUPPE B1a-UGL EN 14411 ANL. G UND ISO 13006 ANLG. / CLASSIFICATION SELON LES NORMES CEN ET ISO GROUPE B1a-UGL EN 14411 P.J.G ET ISO 13006 P.J.G

PROPRIETÀ CHIMICO - FISICHE / CHEMICAL / PHYSICAL PROPERTIES / CHEMISCH PHYSISCHE EIGENSCHAFTEN / PROPRIÉTÉS CHIMICO - PHYSIQUES / NORMA / REGULATION / NORMEN / NORME / VALORE PRESCRITTO / REQUIRED VALUE / VORGESCHRIEBENER WERT / VAUER PRESCRITE / VALORI MEDI ARIOSTEA / ARIOSTEA AVERAGE VALUES / ARIOSTEA DURCHSCHNITTSWERTE / VALEURS MOYENNES ARIOSTEA /

	ASSORBIMENTO D'ACQUA WATER ABSORPTION / WASSERAUFNAHME / ABSORPTION D'EAU	ISO 10545-3	≤ 0,5 %	0,02% - 0,04%
			± 0,6% max LUNGHEZZA E LARGHEZZA / LENGHT AND WIDTH / LÄNGE UND BREITE / LONGUEUR ET LARGEUR	± 0,1% LUNGHEZZA E LARGHEZZA / LENGHT AND WIDTH / LÄNGE UND BREITE / LONGUEUR ET LARGEUR
			± 5% max SPESSORE / THICKNESS / STÄRKE / EPAISSEUR	± 5% SPESSORE / THICKNESS / STÄRKE / EPAISSEUR
	DIMENSIONI SIZES / ABMESSUNGEN / DIMENSIONS	ISO 10545-2	± 0,5% max RETTILINEITÀ* SPIGOLI / LINEARITY / KANTENGERADHEIT / RECTITUDE DES ARÊTES	± 0,1% RETTILINEITÀ* SPIGOLI / LINEARITY / KANTENGERADHEIT / RECTITUDE DES ARÊTES
			± 0,6% max ORTOGONALITÀ* / WEDGING / RECHTWINKLIGKEIT / ORTHOGONALITÉ	± 0,1% ORTOGONALITÀ* / WEDGING / RECHTWINKLIGKEIT / ORTHOGONALITÉ
			± 0,5% max PLANARITÀ* / WARPAGE / EBENFLÄCHIGKEIT / PLANÉITÉ	± 0,2% max 2 mm PLANARITÀ* / WARPAGE / EBENFLÄCHIGKEIT / PLANÉITÉ
	ASPETTO / APPEARANCE / AUSSEHEN / ASPECT		95% MIN. ESENTE DA DIFETTI / MIN. 95% DEFECT FREE / MINDESTENS ZU 95% FEHLERFREI / 95% MIN. SANS DÉFAUTS	CONFORME / CONFORMS / KONFORM / CONFORME
	RESISTENZA ALL'ABRASIONE PROFONDA / DEEP ABRASION RESISTANCE / TIEFVERSCHLEISSBESTÄNDIGKEIT / RESISTANCE A L'ABRASION PROFONDE	ISO 10545-6	max 175 mm ³	140 mm ³
	RESISTENZA AI PRODOTTI CHIMICI RESISTANCE TO CHEMICAL PRODUCTS / CHEMIKALIENBESTÄNDIGKEIT / RESISTANCE AUX PRODUITS CHIMIQUES	ISO 10545-13	UBmin	CONFORME / CONFORMS / KONFORM / CONFORME
	RESISTENZA ALLE MACCHIE STAIN RESISTANCE / FLECKENBESTÄNDIGKEIT / RESISTANCE AUX TACHES	ISO 10545-14	METODO DI PROVA DISPONIBILE / TESTING METHOD AVAILABLE / VERFÜGBARES PRÜFVERFAHREN / MÉTHODE D'ESSAI DISPONIBLE	CLASSE 5 / CLASS 5 / KLASSE 5 / CLASSE 5
	MODULO DI ROTTURA (R) MODULS OF RUPTURE (R) / BRUCHMODUL (R) / MODULE DE RUPTURE (R)	ISO 10545-4	≥ 35 N/mm ²	48 N/mm ²
	RESISTENZA SBALZI TERMICI RESISTANCE TO THERMAL SHOCKS / TEMPERATURWECHSELBESTÄNDIGKEIT / RESISTANCE AUX ECARTS DE TEMPERATURE	ISO 10545-9	METODO DI PROVA DISPONIBILE / TESTING METHOD AVAILABLE / VERFÜGBARES PRÜFVERFAHREN / MÉTHODE D'ESSAI DISPONIBLE	RESISTENTE / RESISTANT / BESTÄNDIG / RESISTANT
	RESISTENZA COLORI ALLA LUCE RESISTANCE TO LIGHT/LICHTBESTÄNDIGKEIT DER FARBEN/RESISTANCE DES COULEURS A LA LUMIERE	DIN 51094		SUP. INALTERATA / UNAFFECTED SURFACE / OBERFLÄCHE UNVERÄNDERT / SURFACE INALTEREE /
	DILATAZIONE TERMICA LINEARE COEFFICIENT OF LINEAR THERMAL EXPANSION / LINEARER WÄRMEAUSSDEHNUNGSKOEFFIZIENT / DILATATION THERMIQUE LINEAIRE	ISO 10545-8	METODO DI PROVA DISPONIBILE / TESTING METHOD AVAILABLE / VERFÜGBARES PRÜFVERFAHREN / MÉTHODE D'ESSAI DISPONIBLE	6,2X10 ⁻⁶ °C ⁻¹
	RESISTENZA AL GELO / FROST RESISTANCE / FROSTBESTÄNDIGKEIT / RESISTANCE AU GEL	ISO 10545-12	RICHIESTI 100 CICLI DI GELO-DISGELO / REQUESTED 100 FREEZE-THAW CYCLES / 100 GEFRIER-AUFTAUZYKLEN ANGEFRAGT / DEMANDÉE 100 CYCLES DE GEL-DÉGEL /	RESISTENTE / RESISTANT / BESTÄNDIG / RESISTANT
	COEFFICIENTE DI ATTRITO / FRICTION COEFFICIENT / REIBUNGSKOEFFIZIENT / COEFFICIENT DE FRICTION	DIN 51130/51097		*

STANDARDS ANSI/ASTM DISPONIBILI A RICHIESTA /
ANSI/ASTM STANDARDS AVAILABLE ON DEMAND /
ANSI/ASTM STANDARDS VERFÜGBARE AUF ANFRAGE /
ANSI/ASTM STANDARDS DISPONIBLES SUR DEMANDE /

* VEDI TABELLA SAFE SYSTEM /
SEE SAFE SYSTEM TABLE /
SIEHE TABELLE SAFE SYSTEM /
VOIR TABLEAU SAFE SYSTEM /

PENDOLUM

SPANISH PENDOLUM TEST ENV12633

COLLEZIONE ARIOSTEA ARIOSTEA COLLECTIONS KOLLEKTIONEN ARIOSTEA COLLECTION ARIOSTEA	SUPERFICIE SURFACE OBERFLÄCHE SURFACE	CLASSE CLASS KLASSE CLASSE
---	--	-------------------------------------

LEGNI HIGH-TECH

Anticato / Antiqued /
Antik / Antique *

2

* Test effettuato su Rovere Moka e Rovere Biondo / Test performed on Rovere Moka and Rovere Biondo /
Test mit Rovere Moka und Rovere Biondo durchgeführt / Essai effectué sur Rovere Moka et Rovere Biondo

INFORMAZIONI TECNICHE AGGIUNTIVE

ADDITIONAL TECHNICAL INFORMATION /

ZUSÄTZLICHE TECHNISCHE INFORMATIONEN / INFORMATION TECHNIQUE SUPPLÉMENTAIRE

• La trasformazione di materie prime naturali, associata all'utilizzo di innovative tecnologie di produzione brevettate, consente di ottenere materiali dalle elevate prestazioni tecniche, che si distinguono per i tipici effetti a tutto spessore da sempre prerogativa esclusiva dei marmi e delle pietre di cava.

• Le variazioni cromatiche, di venatura e le piccole puntinature sono pertanto caratteristiche di alto pregio dei materiali Ariostea, ricercate e volute proprio al fine di ricreare la suggestione di una pavimentazione esclusiva, in cui si possa riscoprire la casualità e la bellezza dei materiali naturali. In ragione di quanto sopra i riferimenti cromatici presentati su cataloghi e campionature sono da intendersi puramente indicativi.

• The processing of natural raw materials, combined with the use of leading-edge patented production techniques, makes it possible to obtain high-tech materials characterized by typical full-body effects, a feature that has always been the exclusive hallmark of quarried marble and stone.

• Chromatic variations, veining and speckling are thus prized characteristics of Ariostea materials, designed and produced to recreate the fascination of exclusive floorings, that reveal the randomness and beauty of natural materials. On the basis of the above statements, the colour references in the catalogues and samples are to be considered as approximate.

• Die Umwandlung von natürlichen Rohmaterialien mit Hilfe von innovativen und patentierten Produktionstechnologien, ermöglicht die Herstellung von Materialien mit hoher technischer Leistungsfähigkeit, die sich durch die typischen vollgemischten Effekte unterscheiden und die seit jeher die charakteristische Besonderheit der Marmorarten und der Steine aus dem Steinbruch sind.

• Die farblichen Unterschiede, die Äderungen und die kleinen Punkte sind aus diesem Grund charakteristische Eigenschaften der Materialien Ariostea von besonderem Wert. Diese "Unvollkommenheiten" sind besonders gewählt und gewollt, um einen exklusiven Bodenbelag zu erzielen, bei dem die Zufälligkeit und die Schönheit der natürlichen Materialien voll zum Ausdruck kommen können. Angesichts der oben aufgeführten Tatsache sind die Farben der Kataloge und der Muster unverbindlich.

• La transformation de matières premières naturelles, alliée à l'application de technologies de production d'avant-garde brevetées, permet d'obtenir des matériaux capables de performances techniques élevées se distinguant par leurs effets pleine masse typiques qui sont depuis toujours la prérogative exclusive des marbres et des pierres de carrière.

• Les variations chromatiques, les veines et les petits points sont donc des caractéristiques de grande valeur des matériaux Ariostea, recherchées et voulues dans le but de recréer la suggestion d'un sol exclusif grâce auquel il est possible de redécouvrir l'impondérable et la splendeur des matériaux naturels. C'est la raison pour laquelle les références chromatiques présentées sur les catalogues et les échantillons ne sont données qu'à titre indicatif.

• Le lastre delle collezioni High-Tech sono realizzate in massa unica, compatta, ingeliva e resistente agli attacchi chimici. Esse sono pertanto una garanzia di stabilità e durevolezza nel tempo, idonee a qualunque impiego e ad ogni ambiente sia interno che esterno, dal più classico e raffinato, al più ampio e di intenso utilizzo.

• Per ottenere un ottimo risultato estetico è preferibile posare il materiale con una fuga di 2-3 mm utilizzando stuccature in tinta.

Ariostea si riserva di apportare modifiche senza preavviso ai prodotti, declinando ogni responsabilità per danni diretti o indiretti da eventuali modifiche.

• The slabs of the High-Tech collections are realized with a 100% full body, a compact and frost-proof mass and they are resistant to chemical attacks. For this reason they are a guarantee of stability and durability in the time, suitable for whatever use and destination, both interior and exterior, from the more classic and refined, to the most spacious and of intense utilization one.

• For a better aesthetic result, is preferable to spread out the material with a 2-3 mm of joint, jointing with tone on tone colours.

Ariostea keeps the right to change all the mentioned items without notice and declining any responsibility for direct or indirect damage caused from these changes.

• Die Platten der Kollektionen High-Tech werden in einziger, vollgemischter, kompakter, frost- und chemikalienbeständiger Masse hergestellt. Deshalb sind sie eine Garantie für Stabilität und Haltbarkeit im Laufe der Zeit, geeignet für jegliche Nutzung und für jedes Ambiente, sowohl für Innen- als Außenbereiche, von den klassischsten und raffiniertesten, bis zu den größten mit intensiver Nutzung.

• Um eine optimale Ästhetik zu erreichen, es ist vorzuziehen, das Material mit einer Fuge von 2-3 mm zu verlegen und Verfugungen in ähnlichen Farbtönen zu verwenden.

Ariostea behält sich vor, ohne Ankündigung Änderungen an den Produkten vorzunehmen, und lehnt jede Haftung für direkte oder indirekte Schäden durch eventuelle Änderungen ab.

• Les dalles de les collections High Tech sont réalisées en une unique masse, compacte, résistante au gel et aux attaches chimiques. Ces dalles sont donc une garantie de stabilité et durabilité dans le temps, elles sont indiquées pour toute utilisation soit pour l'intérieur que l'extérieur, pour tous endroits de plus classique et raffiné au plus large et à grand passage.

• Pour obtenir un excellent résultat esthétique, est préférable de poser le matériau avec un joint de 2-3 mm utilisant le Jointoiment en couleurs ton sur ton.

Ariostea se réserve le droit d'apporter, sans préavis, des modifications aux produits, et décline toute responsabilité pour dommages directs ou indirects, des éventuelles modifications.

CERTIFICAZIONI DI SOSTENIBILITÀ

CERTIFICATION FOR SUSTAINABILITY / ZERTIFIZIERUNG DER NACHHALTIGKEIT / CERTIFICATIONS DE DURABILITÉ

CERTIFICAZIONE LEED: Già diffusa ed attiva in oltre 40 Paesi, il sistema di certificazione LEED (Leadership in Energy and Environmental Design) valuta ed attesta la sostenibilità ambientale, sociale ed economica degli edifici considerati nel loro complesso. Secondo i criteri di classificazione LEED, i materiali da costruzione con elevata ecosostenibilità contribuiscono all'ottenimento di crediti elevando il punteggio dell'edificio. Si certifica che le lastre Ariostea presentate in questo strumento contengono una percentuale di impasto riciclato (pre consumer) superiore al 40% : garantiscono quindi i più alti punteggi secondo il sistema LEED.

CERTIFICAZIONE BREEAM: E' tra i più diffusi standard al mondo ed è volto a misurare l'impatto ambientale degli edifici mediante l'applicazione di specifici criteri di valutazione della sostenibilità della costruzione. il sistema di assegnazione del punteggio prevede tipologie di certificazione fissati da rigorosi parametri tecnici e di controllo qualità basati sulle più recenti tecnologie e conoscenze disponibili.

LEED CERTIFICATION: Currently widespread and used in over 40 countries, the certification system LEED (Leadership in Energy and Environmental Design) evaluates and certifies social and economic environmental sustainability of buildings considered as a whole. According to the classification criteria of LEED, building materials having a high environmental sustainability contribute to obtaining credits thus increasing the building's rating. We certify that the Ariostea tiles in question contain more than 40% (pre-consumer) recycled material: therefore they guarantee the highest LEED ratings.

BREEAM CERTIFICATION: It is the most widespread standard in the world and it is designed to measure the environmental impact of buildings by applying specific criteria for assessing the sustainability of the construction. The rating system requires types of certification determined by strict technical parameters and quality control which in turn are based on the most recent technology and knowledge available.

CERTIFICAZIONI DI PRODOTTO

PRODUCT CERTIFICATIONS / PRODUKTPRÜFBERICHTE / CERTIFICATIONS DE PRODUIT

ITALY



Centro Ceramico
Bologna Italy

U.S.A.



American Society
for Testing and Materials

FRANCE



UKRAINE



RUSSIA



State Sanitary-Epidemic
Department of Russian Federation

Certificazioni di prodotto

Certificazioni rilasciate per i materiali Ariostea dai seguenti organismi ufficiali.

Product certifications

Certifications issued for Ariostea materials by the following official bodies.

Produktprüfberichte

Diese prüfberichte sind für die Materialien Ariostea von den folgenden öffentlichen Behörden ausgestellt worden

Certifications de produit

Certifications délivrées pour les matériaux Ariostea par les organismes officiels suivants:

* La liste à jour des matériaux Ariostea certifiés UPEC est disponible sur le site internet www.cstb.fr

LEED-ZERTIFIZIERUNGEN: Das bereits in mehr als 40 Ländern präsente und aktive Zertifizierungssystem LEED (Leadership in Energy and Environmental Design) prüft und bestätigt die umweltfreundliche, soziale und ökonomische Nachhaltigkeit der Bauten in ihrer Gesamtheit. Den Klassifizierungskriterien von LEED entsprechend tragen hochrangig ökonachhaltige Baumaterialien dazu bei, Pluspunkte für das Gebäude zu sammeln.

Es wird bestätigt, dass die in diesem Instrument vorgelegten Ariostea-Platten einen Prozentsatz von mehr als 40 % an wiederverwerteter Mischung (pre-consumer) enthalten: Sie gewährleisten also nach dem LEED-System die höchsten Punktezahlen.

BREEAM-ZERTIFIZIERUNG: Sie gehört zu den weltweit am meisten verbreiteten Standards und dient dazu, die Umweltbelastung der Gebäude mit speziellen Beurteilungskriterien der Nachhaltigkeit des Baus zu bemessen. Die Zuerkennung der Punktebewertung sieht Zertifizierungen vor, die nach strengen, auf den neuesten Technologien und Erkenntnissen aufbauenden Maßstäben von Technik und Qualitätskontrolle festgelegt sind.

CERTIFICATION LEED: Déjà présent et actif dans plus de 40 Pays, le système de certification LEED (Leadership in Energy and Environmental Design) évalue et certifie la compatibilité environnementale, sociale et économique des bâtiments dans leur ensemble. Conformément aux critères de classification LEED, les matériaux de construction à éco-durabilité élevée favorisent l'obtention de crédits en faisant monter la cote du bâtiment. Les plaques carrelages Ariostea présentées dans ce document contiennent un pourcentage de gâchage recyclé (pré-consommateur) de plus de 40 %: elles obtiennent donc les scores les plus élevés selon le système LEED.

CERTIFICATION BREEAM: C'est l'une des normes les plus répandues au monde et elle permet de mesurer l'impact environnemental des bâtiments selon des critères précis d'évaluation de la durabilité de la construction. Le système d'attribution du score prévoit des types de certification établis selon des paramètres techniques rigoureux et des contrôles qualité basés sur technologies et les connaissances disponibles les plus récentes.

MARCHIO CE

CE MARK / CE ZEICHEN / MARQUE CE

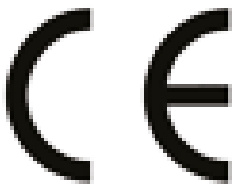

Indica che i prodotti Ariostea sono conformi a quanto richiesto dal regolamento UE 1221/09, in particolare ai requisiti di protezione e sicurezza per il consumatore e che perciò possono liberamente circolare all'interno del Mercato Comune. Per visualizzare le dichiarazioni di conformità di ogni singolo prodotto Ariostea, consultare il sito www.ariostea.it.

It indicates that Ariostea products comply with the requirements of 1221/09 UE directive – in particular with regard to health production and the users and consumers' safety – and may thus be freely circulated on the Community market. For the declarations of conformity of each single product, please refer to www.ariostea-high-tech.com website.

Es bedeutet dass die Ariostea Produkte der Europäischen 1221/09 UE in besonderen den Schutz – und Sicherheitsnormen dem Verbraucher gegenüber entsprechen. Aus diesem Grund dürfen sie auf dem ganzen Gemeinsamen Markt frei umlaufen. Konformitätserklärungen finden Sie auf der Webseite www.ariostea.biz.

Cette marque signifie que les produits de Ariostea respectent la Directive UE 1221/09 sur les normes de sûreté et de protection du consommateur et qui peuvent circuler librement dans le Marché Commun. Pour les déclarations de conformité de chaque produit, veuillez visiter le site Internet www.ariostea.eu.

CERTIFICAZIONI DI SISTEMA

SYSTEM CERTIFICATION / ZERTIFIZIERUNG / SYSTÈME DE CERTIFICATION



SISTEMA DI GESTIONE AMBIENTALE CERTIFICATO UNI EN ISO 14001

Certified environmental
management system.

Umweltschutzsystem zertifiziert.
Gestion environnementale certifiée.

Certificazione ISO 14001 per il proprio Sistema di Gestione Ambientale, che riconosce la validità delle misure adottate dall'azienda per salvaguardare l'ambiente interno ed esterno. Con questa certificazione la nostra azienda conferma il suo impegno nell'assicurare il rispetto delle leggi relative all'ambiente e alla sicurezza, e nel gestire, preservare e ove possibile diminuire, l'utilizzo di risorse naturali e prevenire o ridurre al minimo l'inquinamento.

ISO 14001 certification for its Environmental Management System, validating the company's measures with to protect the environment both in-house and out-house. This certification our company confirms dedication to conform to environmental and safety regulations and to manage, preserve and, when possible, cut down on the use of natural resources and prevent or minimize pollution.

Zertifikat ISO 14001 für das unternehmenseigene Umweltmanagement-System, mit dem die Gültigkeit der vom Unternehmen für den Umweltschutz ergriffenen Maßnahmen innerhalb und außerhalb des Werks anerkannt wird. Mit diesem Zertifikat bekräftigt das Unternehmen sein Bestreben zur Einhaltung der Umwelt- und Sicherheitsgesetze. Außerdem wird versucht, den Einsatz der natürlichen Ressourcen stets auf dem gleichen Stand zu halten und diesen sofern möglich zu verringern. Dazu wird angestrebt, die Umweltbelastung zu vermeiden oder auf ein Minimum zu reduzieren.

Certification ISO 14001 pour son Système de Gestion Environnementale, qui reconnaît la validité des mesures adoptées par l'entreprise pour préserver l'environnement dans ses propres installations et à l'extérieur. Grâce à cette certification, confirme son engagement pour assurer le respect des lois relatives à l'environnement et à la sécurité et à gérer, préserver et dans la mesure du possible à réduire l'utilisation de ressources naturelles et à prévenir ou réduire au minimum la pollution.



SISTEMA DI GESTIONE QUALITÀ CERTIFICATO UNI EN ISO 9001

Certified quality system.
Qualitätssystem zertifiziert.
Système qualité certifié.

Certificazione ISO 9001 per la gestione del sistema di Qualità aziendale. La certificazione, valida a livello internazionale, riguarda l'intera gestione aziendale, dalla ricerca e sviluppo alla produzione, dalla distribuzione all'assistenza al cliente.

ISO 9001 certification for management of its company quality system. This certification, valid at the international level, concerns the entire company management system, from research and development to production, and from distribution to customer service.

Zertifikat ISO 9001 für die Verwaltung des unternehmenseigenen Qualitätsmanagementsystems. Diese international anerkannte Zertifizierung betrifft die gesamte Unternehmensführung, von Forschung und Entwicklung, über die Produktion bis hin zu Vertrieb und Kundendienst.

Certification ISO 9001 pour la gestion du système Qualité de l'entreprise. La certification, valable au niveau international, concerne tout le système de l'usine, de la recherche et développement à la production, à la distribution et à l'assistance au client.

I punti di forza che sotto il profilo ambientale e qualitativo caratterizzano la produzione di Ariostea sono:

- utilizzo di materie prime naturali a basso impatto ambientale, in quanto ampiamente diffuse sulla crosta terrestre e non a rischio di esaurimento (come invece si verifica per alcuni materiali lapidei);
- processi produttivi ad elevate performance qualitative ed ambientali, ciò grazie a fonti energetiche pulite come il gas metano per la produzione di energia termica;
- ridottissimi consumi di acqua, attraverso la creazione di impianti di trattamento e riciclo completo delle acque reflue industriali, provenienti soprattutto dai lavaggi degli impianti, e l'attivazione di un sistema di approvvigionamento di acqua industriale (acqua di fiume appositamente trattata). Tutto ciò permette una drastica riduzione dei consumi idrici, l'eliminazione di qualsiasi scarico di acque reflue e, soprattutto, un quasi inesistente utilizzo di acqua potabile;
- ciclo dei materiali chiuso: ovvero non esiste generazione di scarti durante la lavorazione, grazie al sistema di recupero ed al riutilizzo di tutti i residui adottato da Ariostea;
- riciclaggio ottimale dei rifiuti differenziati;
- durabilità nel tempo senza particolari necessità di manutenzione, grazie alle ottime caratteristiche di igiene e di praticità dei prodotti Ariostea;
- elevata compatibilità allo smantellamento del pavimento/rivestimento, come definito dalle attuali legislazioni. In particolare, i residui derivanti dallo smantellamento, in ragione della loro inerzia, non richiedono trattamenti particolari e possono facilmente essere riutilizzati come inerti non rilasciando alcun genere di sostanza pericolosa e non.

The salient features of Ariostea's production, in terms of environment and quality, are as follows:

- Use of natural raw materials that ensure minimal environmental impact, being broadly available in the earth's crust and not at the risk of depletion (as in the case of various types of stone);
- Production processes of a high quality and environmental standard, using clean sources of energy such as methane gas for the production of heat energy;
- Minimal consumption of water. We use plants that treat and recycle all industrial waste water used mainly for cleaning the equipment, as well as an industrial water supply system (which uses appropriately treated river water). This serves to drastically reduce our consumption of water, eliminates virtually all disposal of waste water and, above all, ensures we do not use nearly any potable water;
- Closed work cycle: this means no waste is generated during the work phase due to Ariostea's system that recovers and reuses all residue;
- Optimal recycling of segregated waste;
- Long-lasting durability, without any particular need for maintenance due to the excellent standards of hygiene and practicality of Ariostea's products;
- The floor/wall tiles are designed in such a way that they can be easily taken up again, as per the law in force. In particular, any residue created when taking up the tiles does not require special treatment due to its inertia and can be easily re-used as inert matter without releasing any substances, dangerous or otherwise.



Iscrizione al Registro EMAS, uno degli strumenti con cui la Comunità Europea interviene per la tutela dell'ambiente, allo scopo di realizzare uno sviluppo economico sostenibile, mettendo in rilievo il ruolo e la responsabilità delle imprese. La nostra Azienda ha quindi deciso di aderire al programma EMAS per perseguire obiettivi di miglioramento costante della propria efficienza ambientale e di trasparenza nei confronti dell'opinione pubblica.

Registration with EMAS, the EU's eco-management scheme that aims for sustainable economic development and stresses the role and responsibility of businesses in this regard. Our Company joined EMAS with the intention of constantly improving upon environmental efficiency and transparent relations with the public.

Eintragung in das EMAS-Register, eines der Systeme, mit denen die Europäische Gemeinschaft zum Schutz der Umwelt eingreift, um eine nachhaltige wirtschaftliche Entwicklung zu erreichen, indem sie die Rolle und die Verantwortlichkeit der Unternehmen in den Vordergrund rückt. Unser Unternehmen hat sich daher entschlossen, sich dem EMAS-Programm anzuschließen und das Ziel einer beständigen Verbesserung in Bezug auf Umwelteffizienz und Transparenz gegenüber der öffentlichen Meinung zu verfolgen.

Inscription au Registre EMAS, l'un des outils grâce auxquels la Communauté européenne intervient pour la protection de l'environnement, afin de réaliser un développement économique durable, en mettant en avant le rôle et la responsabilité des entreprises. Notre Société a donc choisi d'adhérer au programme EMAS pour poursuivre les objectifs d'amélioration constante de sa propre efficacité environnementale et de transparence vis-à-vis du grand public.

Die Stärken, welche die Produktion von Ariostea in Hinsicht auf Umweltschutz und Qualitätsgesichtspunkte kennzeichnen, sind:

- Die Verwendung von natürlichen Rohmaterialien mit geringer Umweltbelastung, die dank ihres häufigen Vorkommens keine Gefahr der Erschöpfung laufen (wie das dagegen bei einigen Steinmaterialien der Fall ist);
- Herstellungsverfahren mit hoher Leistung in punkto Qualität und Umwelt, dies auch dank sauberer Energiequellen wie Methangas zur Erzeugung von thermischer Energie;
- Extrem geringer Wasserverbrauch dank der Einrichtung von Wiederaufbereitungsanlagen für die Behandlung und das komplette Recycling der industriellen Abwässer, die vor allem von den Waschvorgängen der Anlagen stammen, sowie die Aktivierung eines Versorgungssystems für Industrierwasser (entsprechend behandeltes Flusswasser). All dies ermöglicht eine drastische Verringerung des Wasserverbrauchs, das Entfallen jeglicher Art der Abwasserentsorgung und was wesentlich wichtiger ist, fast absolut keinen Einsatz von Trinkwasser;
- Ein geschlossener Materialzyklus: das bedeutet, dass dank des von Ariostea eingesetzten Wiedergewinnungs- und Wiederverwertungssystems sämtlicher Rückstände während der Verarbeitung keine Abfälle erzeugt werden;
- Optimale Wiederverwertung der getrennten Abfälle;
- Eine zeitlose Dauerhaftigkeit ohne besondere Wartungsmaßnahmen dank der optimalen hygienischen Eigenschaften und der Zweckmäßigkeit der Produkte von Ariostea;
- Hohe Abrissverträglichkeit des Bodenbelags/der Wandverkleidung, so wie es die derzeitige Gesetzgebung verlangt. Insbesondere erfordern die Abrissrückstände keine besonderen Behandlungsverfahren und können leicht als inerte Stoffe wieder verwendet werden, da sie keine Art von Gefahrenstoffen beinhalten oder freigeben.

Les points forts qui sous le profil environnemental et qualitatif caractérisent la production d'Ariostea sont:

- utilisation de matières premières naturelles à faible impact environnemental, largement répandues sur l'écorce terrestre et qui ne risquent pas de s'épuiser (comme cela est au contraire le cas pour certains matériaux lapidaires);
- processus de production ayant des performances qualitatives et environnementales élevées, grâce à des sources énergétiques propres comme le gaz méthane pour la production d'énergie thermique;
- consommation d'eau extrêmement réduite, grâce à la création d'installations de traitement et de recyclage complet des eaux usées, provenant surtout des lavages des installations, et l'activation d'un système d'approvisionnement d'eau industrielle (eau de fleuve correctement traitée). Tout ceci permet une réduction importante des consommations hydriques, l'élimination des évacuations d'eaux usées et, surtout, une utilisation presque inexistante d'eau potable ;
- cycle fermé des matériaux : c'est-à-dire lorsqu'il n'y a pas de déchets générés au cours de la fabrication, grâce au système de recyclage et d'utilisation de l'ensemble des rebuts, adopté par Ariostea;
- recyclage optimal des déchets différenciés;
- durabilité dans le temps, sans aucun entretien, grâce aux excellentes propriétés d'hygiène et d'utilisation des produits d'Ariostea;
- excellente compatibilité au moment de la destruction des dalles/revêtements telle que préconisée par les législations actuelles. Notamment pour les déchets provenant de la destruction, en raison de leur inertie, qui ne demandent aucun traitement particulier et qui peuvent être facilement réutilisés en tant qu'inertes qui ne génèrent aucune substance dangereuse.

SAFE SYSTEM

CLASSIFICAZIONE RESISTENZA ALLO SCIVOLAMENTO / SLIP RESISTANCE CLASSIFICATION /
 KLASSIFIZIERUNG DER RUTSCHFESTIGKEIT / RÉSISTANCE AU GLISSEMENT

AN: Anticato / Antiqued / Antik / Antique
SO: Soft



NORMA DIN 51130	
R9 6° - 10°	COEFFICIENTE DI ATTRITO NORMALE AVERAGE FRICTION COEFFICIENT NORMALER REIBUNGSKOEFFIZIENT COEFFICIENT DE FROTTEMENT MOYEN

COLLEZIONE / COLLECTION / KOLLEKTION / COLLECTION	FINITURA / FINISH / OBERFLÄCHEN AUSFÜHRUNG / FINITION	DIN 51097
--	--	-----------

ULTRA WOOD		SO	-
LEGNI HIGH-TECH	ROVERE BIONDO ROVERE SABBIA	AN	A
WOODDRAW	ARTIC ASH BOARD POWDER RUST	AN	-

NORMA DIN 51130	
R10 10° - 19°	COEFFICIENTE DI ATTRITO NORMALE AVERAGE FRICTION COEFFICIENT NORMALER REIBUNGSKOEFFIZIENT COEFFICIENT DE FROTTEMENT MOYEN

COLLEZIONE / COLLECTION / KOLLEKTION / COLLECTION	FINITURA / FINISH / OBERFLÄCHEN AUSFÜHRUNG / FINITION	DIN 51097
--	--	-----------

INNOVATIVE SLABS LEGNI HIGH-TECH	QUERCIA TROPICALE QUERCIA PETRAEA QUERCIA BIANCA QUERCIA CANADESE QUERCIA SHABBY	AN	A+B
LEGNI HIGH-TECH	ROVERE ABBAZIA ROVERE ANTICO ROVERE BIANCO ROVERE CENERE ROVERE CILIEGIO ROVERE CORDA ROVERE COUNTRY ROVERE DECAPÈ ROVERE IMPERO ROVERE NATURALE ROVERE NOCE ROVERE PROVENZALE ROVERE REALE ROVERE TUNDRA	AN	A A A+B+C A+B A+B A A A A A A+B A+B A A

NORMA DIN 51130	
R11 19° - 27°	COEFFICIENTE DI ATTRITO SUPERIORE ALLA NORMA ABOVE AVERAGE FRICTION COEFFICIENT ÜBERDURCHSCHNITTLICHER REIBUNGSKOEFFIZIENT COEFFICIENT DE FROTTEMENT SUPERIEUR A LA NORME

COLLEZIONE / COLLECTION / KOLLEKTION / COLLECTION	FINITURA / FINISH / OBERFLÄCHEN AUSFÜHRUNG / FINITION	DIN 51097
--	--	-----------

LEGNI HIGH-TECH	ROVERE BRICCOLA ROVERE GRIGIO ROVERE MOKA ROVERE NERO	AN	A+B A A+B A+B+C
CM2 - LEGNI HIGH-TECH	ROVERE SABBIA ROVERE CENERE ROVERE BRICCOLA ROVERE IMPERO ROVERE GRIGIO ROVERE TUNDRA	AN	A+B A+B A+B A+B A+B A+B

n.b: I valori di resistenza allo scivolamento, coefficiente di attrito statico o dinamico, riportati sul catalogo e nella tabella Safe System sono da ritenersi puramente indicativi e non vincolanti. Ogni eventuale specifica necessità dovrà essere da noi confermata al momento dell'ordine e comunque sempre prima della posa.

nb: Slip resistance values, coefficient of static or dynamic friction, in the catalog and in the Safe System Table are purely indicative and not binding. Any specific requirements must be confirmed by us at the time of ordering and in any case before installation.

Anm.: Die Werte für die Rutschfestigkeit, also des statischen oder dynamischen Reibungskoeffizienten, die im Katalog oder in der Tabelle Safe System aufgeführt sind, sind als unverbindliche Richtwerte anzusehen. Alle spezifischen Anforderungen müssen von uns bei der Bestellung und in jedem Fall vor der Verlegung immer bestätigt werden.

n.b: Les valeurs de résistance au glissement, le coefficient de frottement statique ou dynamique, indiqués sur le catalogue et sur le tableau Safe System (Système de Sécurité) doivent être considérés comme purement indicatifs et ne sauraient engager notre responsabilité. Toutes les éventuelles spécifications nécessaires devront faire l'objet d'une confirmation de notre part au moment de la commande et en tout état de cause avant la pose.

GRADO DI VARIAZIONE CROMATICA

DEGREE OF COLOUR CHANGE / GRAD DER FARBABWEICHUNG / DEGRE DE VARIATION CHROMATIQUE

ULTRA WOOD

NOCE AMERICANO	V3
NOCE CALCE	V3
NOCE CHIARO	V3
NOCE OSSIDATO	V3
NOCE SCURO	V3

INNOVATIVE SLABS

LEGNI HIGH-TECH	
QUERCIA BIANCA	V3
QUERCIA CANADESE	V3
QUERCIA TROPICALE	V3
QUERCIA PETRAEA	V3
QUERCIA SHABBY	V2

LEGNI HIGH-TECH

ROVERE ABBAZIA	V3
ROVERE ANTICO	V3
ROVERE BIANCO	V2
ROVERE BIONDO	V4
ROVERE BRICCOLA	V2
ROVERE CENERE	V3
ROVERE CILIEGIO	V3
ROVERE CORDA	V3
ROVERE COUNTRY	V3
ROVERE DECAPÈ	V3
ROVERE GRIGIO	V4
ROVERE IMPERO	V4
ROVERE MOKA	V4

ROVERE NATURALE	V3
ROVERE NERO	V2
ROVERE NOCE	V4
ROVERE PROVENZALE	V3
ROVERE REALE	V4
ROVERE SABBIA	V3
ROVERE TUNDRA	V2

CM2 - LEGNI HIGH-TECH

ROVERE SABBIA	V3
ROVERE CENERE	V3
ROVERE BRICCOLA	V2
ROVERE IMPERO	V4
ROVERE GRIGIO	V4
ROVERE TUNDRA	V2

WOODDRAW

ARTIC	V3
ASH	V3
BOARD	V4
POWDER	V4
RUST	V4

V1 LOW	PRODOTTO MONOCROMATICO MONOCHROMATIC PRODUCT EINFARBIGES PRODUKT PRODUIT MONOCHROMATIQUE
---------------	---

V2 MODERATE	PRODOTTO CON LEGGERA VARIAZIONE CROMATICA PRODUCT WITH LIGHT CHROMATIC VARIATION PRODUKT MIT LEICHTER FARBNUANCE PRODUIT À LÉGERE VARIATION CHROMATIQUE
--------------------	--

V3 HIGH	PRODOTTO CON MARCATTA VARIAZIONE CROMATICA PRODUCT WITH HIGH SHADE CHROMATIC VARIATION PRODUKT MIT AUSGEPRÄGTER FARBNUANCE PRODUIT À VARIATION CHROMATIQUE ACCENTUÉE
----------------	---

V4 EXTREME	PRODOTTO CON FORTE VARIAZIONE CROMATICA PRODUCT WITH VERY HIGH SHADE CHROMATIC VARIATION PRODUKT MIT STARKER FARBNUANCE PRODUIT À FORTE VARIATION CHROMATIQUE
-------------------	--

LA POSA

INSTALLATION / DIE VERLEGUNG / LA POSE

LA POSA Alla totale riuscita di un pavimento Ariostea concorrono, insieme alle qualità tecniche ed estetiche del materiale, elementi quali sottofondo, strato legante, giunti di dilatazione, che costituiscono un vero e proprio sistema pavimento. Solo la corretta esecuzione delle operazioni di posa assicura un perfetto risultato finale.

La posa deve essere preferibilmente eseguita con collanti idonei, attenendosi alle istruzioni della ditta produttrice degli stessi.

Nei luoghi ad elevato transito o con passaggio di carichi pesanti è consigliabile il sistema a doppia spalmatura.

I materiali Ariostea tendono a simulare la casualità della natura con le sue variazioni cromatiche, che l'abilità del posatore può esaltare.

INSTALLATION In addition to the technical and aesthetic qualities of the material used, the total success of an Ariostea floor installation depends on a series of elements such as bed, adhesive layer and expansion joints, which make up a true flooring system. A correct installation is therefore essential in order to ensure perfect final results.

The installation should be preferably made using proper adhesives, following the instructions provided by the manufacturer. In places subject to heavy traffic or to the passage of heavy loads it is advisable to perform installation at double spread.

Ariostea products tend to replicate the random appearance of natural materials, with their characteristic colour variations, which the skills of the installer can even enhance.

DIE VERLEGUNG Das perfekte Gelingen eines Bodenbelags von Ariostea hängt außer von den technischen und ästhetischen Materialeigenschaften auch von einer Reihe anderer Faktoren ab: Untergrund, Bindeschicht, Dehnungsfugen. Diese bilden ein regelrechtes Fußbodensystem. Nur durch eine fachgerechte Verlegung kann daher ein optimales Endergebnis erzielt werden. Die Verlegung muss am besten mit geeigneten Klebstoffen erfolgen, und es wird angeraten, die Angaben des jeweiligen Herstellers genau zu befolgen. In Räumen mit hoher Begehungsfrequenz oder bei Beanspruchung durch schwere Lasten empfiehlt sich die Verlegung an doppelter Ausbreitung. Die Fliesen von Ariostea haben die Neigung, die für Naturprodukte typische Zufälligkeit mit ihren Farbvariationen nachzubilden, die ein guter Fliesenleger bei seiner Arbeit zu nutzen weiß.

LA POSE La réussite totale d'un sol Ariostea dépend non seulement des qualités techniques et esthétiques du matériau mais aussi de divers éléments (fond, couche de liant et joints de dilatation) qui constituent un véritable système sol. Seules des opérations de pose correctes garantissent un résultat parfait.

De préférence, la pose doit être effectuée par des adhésifs appropriés, et il est conseillé de se conformer aux instructions du fabricant.

Dans les endroits très fréquentés ou soumis au passage de charges lourdes, il est recommandé d'utiliser le système à la double diffusion.

Les matériaux Ariostea imitent le hasard de la nature et ses variations de couleurs, caractéristiques que l'habileté du carreleur peut exalter.

CONSIGLI PER LA POSA DEL CM2 Precisiamo che tutti i formati della collezione CM2 di Ariostea sono idonei per la posa direttamente su massetto, su ghiaia, su sabbia e su erba mentre per la posa in applicazione sopraelevata si devono invece tenere in considerazione alcune specificità in funzione del formato. Nella posa di Ariostea CM2 nel formato 60x60 in applicazione sopraelevata si raccomanda un innalzamento massimo del piano di appoggio non superiore a 10 cm. Si consiglia inoltre l'utilizzo del supporto centrale (5° piedino), per distribuire in modo corretto i vari carichi ed incrementare ulteriormente i già elevati valori di resistenza ai carichi del materiale.

TIPS FOR LAYING CM2 Please note that all of the formats of the CM2 collection of Ariostea are suitable for laying directly on concrete, gravel, sand and on grass while for the laying in an elevated application it is necessary to take into account certain characteristics according to the format. For the laying of Ariostea CM2 in the 60x60 format in an elevated application the elevation of the support surface should not exceed 10 cm. It is also recommended to use the central support (5th leg), to distribute properly the different loads and further increase the already high resistance values of the material to the loads.

TIPPS FÜR CM2 VERLEGE Wir halten fest, dass alle Formate der Kollektion CM2 von Ariostea geeignet sind, direkt auf Beton, Kies, Sand und Gras verlegt zu werden, während bei einem erhöhten Verlegen einige vom Format diktierte Maßnahmen zu berücksichtigen sind. Bei einem erhöhten Verlegen von Ariostea CM2 der Größe 60x60 ist empfohlen, die Auflagefläche um nicht mehr als 10 cm anzuheben. Zudem ist empfohlen, die zentrale Stütze (5. Bein) zu verwenden, um so die unterschiedlichen Belastungen auszugleichen und die an sich schon bedeutende Tragfähigkeit des Materials zu erhöhen.

CONSEILS POUR LA POSE CM2 Précisons que tous les formats de la collection CM2 d'Ariostea conviennent pour la pose directement sur le béton, le gravier, le sable et l'herbe, tandis que pour la pose en surélévation, il faut prendre en compte certaines spécificités en fonction du format. Dans la pose d'Ariostea CM2 au format 60x60, il est recommandé pour la pose surélevée une hauteur maximale de la surface d'appui ne dépassant pas 10 cm. Il est recommandé également d'utiliser un support central (5e pied), pour distribuer au mieux les différentes charges et augmenter encore les valeurs déjà élevées de résistance aux charges matérielles.

Per valorizzare al meglio le caratteristiche del materiale, si consiglia di seguire, durante la posa in opera, le seguenti prescrizioni:

- Stendere a terra alcuni pezzi (almeno 3 mq.) per controllare l'effetto d'insieme. Posare il materiale attingendone da più scatole.
- Non immergere in acqua il materiale prima della posa.
- Soprattutto nelle superfici levigate, per i tagli non segnare la parte superiore da posare con matite o pennarelli.
- Attendere 48-72 ore prima di sottoporre il pavimento al normale transito.
- Per ottenere un ottimo risultato estetico è sempre preferibile posare il materiale con una fuga di 2 mm utilizzando stuccature in tinta.

Follow these instructions to bring out the best in the material:

- Spread out a number of pieces (at least 3 square metres) on the floor to check the overall effect. When laying the material, mix contents of different boxes.
- Do not immerse the material in water before laying.
- With polished surfaces in particular, do not mark the top surfaces with pencils or marker pens where cut are needed.
- Wait 48-72 hours before subjecting the floor to normal use.
- For a better aesthetic result, it is always preferable to spread out the material with 2 mm of joint, jointing with tone on tone colours.

Um die Materialeigenschaften am besten zur Geltung zu bringen, wird empfohlen, während der Verlegung vor Ort die folgenden Hinweise zu befolgen:

- Legen Sie einige Fliesen (mind. 3 m²) auf dem Boden aus, um die Gesamtwirkung zu testen. Entnehmen Sie das Material aus verschiedenen Kartons.
- Legen Sie das Material vor dem Verlegen nicht in Wasser.
- Vor allem bei polierten Oberflächenausführungen vermeiden Sie, den Schnittverlauf an der zu verlegenden Materialoberfläche mit Bleistift oder Filzstift aufzuzeichnen.
- Die normale Begehungsfrequenz wird nur nach 48-72 Stunden erlaubt.
- Um eine optimale Ästhetik zu erreichen, es ist immer vorzuziehen, das Material mit einer Fuge von 2 mm zu verlegen und Verfugungen in ähnlichen Farbtönen zu verwenden.

Afin de rehausser au mieux les caractéristiques du matériau, il est conseillé de suivre, lors de la pose, les indications suivantes:

- Etaler quelques carreaux sur le sol (au moins 3 m²) pour contrôler l'effet d'ensemble. Prélever le matériau de plusieurs boîtes.
- Ne pas immerger le matériau dans l'eau avant la pose.
- Pour la coupe des carreaux, et notamment des surfaces polies, ne pas écrire au crayon ou au feutre sur la face visible.
- Attendre de 48 à 72 heures avant de marcher sur le sol.
- Pour obtenir un excellent résultat esthétique, est toujours préférable de poser le matériau avec un joint de 2 mm utilisant le Jointoiment en couleurs ton sur ton.

È anche possibile prevedere l'utilizzo di lastre di 60x60 in 20 mm di spessore ad altezze superiori ai 10 cm previa applicazione per incollaggio di una rete in fibra di vetro nella parte sottostante della lastra per sopraelevazioni fino a 30 cm. Per sopraelevazioni fino a 50 cm prevedere un foglio di lamiera zincata. In questi ultimi due casi sono sufficienti 4 supporti per lastra. Per la posa sopraelevata di Ariostea CM2 nei formati 120x60 e 120x30 si raccomanda di non superare i 2 cm di altezza prevedendo 6 supporti per lastra mentre per pavimentazioni con innalzamento tra 2 e 10 cm è indispensabile una rete in fibra di vetro e oltre i 10 cm di altezza si dovrà utilizzare un foglio di lamiera zincata.

It is also possible to use 60x60 plates with a thickness of 20 mm and a maximum height of 10 cm after application by bonding of a glass fibre netting in the underlying part of the plate for elevations up to 30 cm. For elevations up to 50 cm a galvanized steel plate will be required. In the latter two cases 4 supports for each plate are enough. For the elevated laying of Ariostea CM2 in the 120x60 and 120x30 formats it is recommended not to exceed 2 cm in height using 6 supports for each plate while for floorings with an elevation between 2 and 10 cm a glass fibre netting is essential and for over 10 cm a galvanized steel plate will be required.

Es ist auch möglich, die Verwendung von Platten des Formats 60x60 und einer Dicke von 20 mm in Höhen von mehr als 10 cm vorzusehen, wobei allerdings für Erhöhungen von bis zu 30 cm ein Glasfaser-Netz auf den unter der Platte vorgesehenen Bereich verklebt werden muss. Für Erhöhungen von bis zu 50 cm ist dafür ein Blatt verzinkten Blechs vorzusehen. In den letzten beiden Fällen sind vier Träger je Platte ausreichend. Für das erhöhte Verlegen von Ariostea CM2 in den Größen 120x60 und 120x30 ist empfohlen, eine Höhe von 2 cm nicht zu überschreiten, wobei 6 Träger je Platte vorzusehen sind, während für zwischen 2 und 10 cm erhöhte Bodenbeläge ein Glasfaser-Netz und bei mehr als 10 cm ein Blatt verzinkten Blechs zu verwenden sind.

Il est également possible d'envisager l'utilisation de dalles de 60x60 en 20 mm d'épaisseur à des hauteurs supérieures à 10 cm après application par collage d'un filet en fibres de verre à la partie inférieure de la dalle pour des surélévations allant jusqu'à 30 cm. Pour des surélévations allant jusqu'à 50 cm, prévoir une tôle d'acier galvanisé. Dans les deux derniers cas, il suffit de 4 supports par dalle. Pour la pose surélevée d'Ariostea CM2 dans les formats 120x60 et 120x30, il est recommandé de ne pas dépasser 2 cm de hauteur en prévoyant 6 supports par dalle, alors que pour un dallage entre 2 et 10 cm, un filet en fibres de verre est indispensable ; au-delà de 10 cm de hauteur, il faudra utiliser une tôle d'acier galvanisé.

STUCCATURA E PULIZIA FINALE

JOINTING AND FINAL CLEANING / VERFUGUNG UND ENDREINIGUNG / JOINTOIEMENT ET NETTOYAGE FINAL

STUCCATURA E PULIZIA FINALE Con collanti a presa normale, stuccare il pavimento dopo 24/48 ore, se si utilizzano adesivi rapidi dopo 4h.

- Soprattutto sui materiali levigati lucidati utilizzare stucchi cementizi con colori tono su tono, evitando su materiali chiari, stucchi di colore scuro e viceversa.
- Per la stuccatura di queste superfici non adoperare stucchi epossidici o malte flessibili a base di materiali sintetici (Flexfughe) soprattutto se a contrasto col colore del materiale e non aggiungere additivi/lattici allo stucco. Essi infatti rendono estremamente difficoltosa l'eliminazione dei residui con i normali prodotti di pulizia. Se si decide comunque di utilizzare questa tipologia di stucco, testarli sempre prima sul materiale.
- Stendere lo stucco con spatola gommata su tutta la superficie del materiale.
- Stuccare piccole superfici per volta, asportando le quantità eccedenti con spugne o stracci umidi (di sola acqua pulita) o utilizzare apposite macchine per

JOINTING AND FINAL CLEANING When the floor has been laid using normal setting adhesives, joint the tiles after 24/48 hours, in the case of quick setting adhesives, after 4 hours.

- Especially with honed and polished materials, use cement-based grout with tone on tone colours (if possible avoid dark coloured grouts like black, blue, red with light coloured materials and vice-versa). For jointing these surfaces, do not use epoxy grouts or flexible mortar with a synthetic base (Flexfughe) especially if the colour contrasts with the material and do not add additives/latex to the grout. These products in fact make it extremely difficult to eliminate the residues with normal cleaning products. Should this kind of grout be used anyway, take care of testing it on the material beforehand.
- Spread the grout with a rubber spatula all over the material surface.
- Joint small areas at a time, removing the excess with damp sponges or rags (using only clean water) or with special machines for removing the excess grout

VERFUGUNG UND ENDREINIGUNG Bei der Verlegung mit normal härtenden Klebern, den Boden nach 24 / 48 Stunden, bei der Verwendung von Schnellklebern bereits nach 4 Stunden verfugen.

- Insbesondere auf den glanzpolierten Materialien sollten Zementkitt in ähnlichen Farbtönen verwendet werden (es sollte vermieden werden, auf hellen Materialien dunkle, beispielsweise schwarze, blaue oder rote Kitt zu verwenden; dasselbe gilt für helle Kitt auf dunklen Fliesen).
- Für das Verfugen dieser Oberflächen auf keinen Fall kunstharzgebundenen Fugenmörtel oder bewegliche Mörtel auf Basis von synthetischen Materialien (z.B. Flexfughe) verwenden, vor allem nicht in Kontrastfarbe zur Fliese. Außerdem dürfen dem Kitt keine Zusatzstoffe oder Latex zugeschlagen werden, da durch diese Zuschläge die Entfernung der Restrückstände mit den normalen Reinigungsmitteln extrem erschwert wird. Sollen Sie sich dennoch für einen kunstharzgebundenen Fugenmörtel entscheiden, testen Sie diesen vorher auf dem Material.
- Den Kitt mit einer Gummispachtel auf der gesamten Materialoberfläche gleichmäßig auftragen.
- Die kleinen Oberflächen einzeln verfugen und die entsprechenden Restrückstände mit einem feuchten Schwamm oder Lappen (der nur in reines Wasser getaucht wurde) entfernen, oder spezielle Maschinen für das Entfernen

JOINTOIEMENT ET NETTOYAGE FINAL En cas de pose avec des adhésifs à prise normale, jointoyer le sol après 24/48 heures; si l'on utilise des adhésifs à prise rapide, après 4h.

- Sur les matériaux polis lustrés surtout, utiliser des mortiers-joints avec des couleurs ton sur ton (éviter si possible sur des matériaux de couleur claire des mortiers de couleur foncée comme le noir, le bleu, le rouge et vice-versa). Pour le jointoiment de ces surfaces, ne pas utiliser Mastics époxydes ou de mortiers flexibles à base de matériaux synthétiques (Flexfughe) surtout s'il y a contraste avec la couleur du matériau, et ne pas ajouter d'additifs/lactiques au mastic. En effet, ces derniers rendent l'élimination des résidus extrêmement difficile avec les nettoyeurs normaux. Si de toute façon on décide de continuer à utiliser ce type de mortier il faudra toujours le tester avant.
- Etaler le mortier à la spatule caoutchoutée sur toute la surface du matériau.
- Jointoyer de petites surfaces à la fois en enlevant les quantités en excès avec une éponge ou des chiffons humidifiés (exclusivement d'eau propre) ou utiliser des machines spéciales pour enlever le mortier en excès quand le voile de

togliere lo stucco eccedente, quando ancora il velo di stucco è umido.

- Un'adeguata pulizia iniziale è fondamentale sia per valorizzare la brillantezza, sia per assicurare la pulibilità e la semplicità di manutenzione ordinaria. La pulizia iniziale va quindi effettuata immediatamente dopo la posa, utilizzando prodotti a base acida, strofinando energicamente e sciacquando abbondantemente con acqua. In questo modo sarà possibile eliminare i residui di stucco, collante, cemento, ecc. E' possibile utilizzare tutti i detergenti disponibili sul mercato, con unica esclusione dei prodotti contenenti acido fluoridrico (composti e derivati) come previsto dalla norma EN 14411.
- Si raccomanda una accurata protezione del pavimento posato. Qualora sia necessario eseguire altre operazioni quali tinteggiatura, lavori idraulici o qualsiasi altro lavoro, si consiglia, terminata la posa, di coprire il pavimento con teli PVC o AIRBALLS o tessuti.

while this is still damp.

- Proper initial cleaning is fundamental both for enhancing its aesthetic and shine characteristics and for restoring its original characteristics of easy cleaning and ease of ordinary maintenance. It is therefore very important that initial cleaning is carried out immediately after installation, rubbing hard with acid-based products, followed by abundant rinsing with water. In this way it will be possible to eliminate the residues of grout, adhesive, cement, etc. It is possible to use any of the detergents available on the market, with the exclusion only of products containing hydrofluoric acids (composites and derivatives) according to EN standard 14411.
- The floor must be carefully protected. Should it be necessary to carry out other operations such as decorating, plumbing or any other kind of work, once the floor has been installed it is advisable to cover it with PVC or AIRBALLS sheets or cloths.

von Restrückständen verwenden, wobei der Kitt noch feucht sein muß.

- Eine korrekte anfängliche Reinigung ist besonders wichtig, weil somit sowohl die ästhetischen Besonderheiten und der Glanz des Materials hervorgehoben werden, und zudem die zukünftigen und lang anhaltenden Eigenschaften der einfachen Reinigung und der praktischen regelmäßigen Pflege dieses Materials zur Geltung kommen können.
- Es ist deshalb sehr wichtig, daß die erste Reinigung mit säurehaltigen Reinigungsmitteln sofort nach der Verlegung des Materials erfolgt, wobei die Fliesen fest zu reiben und dann gründlich mit frischem Wasser zu spülen sind. Auf diese Weise können alle Restrückstände von Kitt, Kleber, Zement usw. gründlich entfernt werden. Zu diesem Zweck können alle erhältlichen Reinigungsmittel verwendet werden, mit Ausnahme aller Produktartikel, die Fluorwasserstoffsäure (Verbindungen und Derivate) enthalten, laut der Vorschrift EN 14411.
- Es wird empfohlen, den verlegten Boden sorgfältig zu schützen. Sollten andere Arbeiten, wie zum Beispiel das Färben, das Verlegen von Heizungs- und Wasserleitungen oder ähnliches erforderlich sein, empfehlen wir den Boden nach dem Verlegen mit Planen aus PVC, AIRBALLS oder Gewebbahnen abzudecken.

mortier est encore humide.

- Un nettoyage initial adapté est d'une importance fondamentale aussi bien pour mettre en valeur les caractéristiques esthétiques et de brillance, que pour rétablir les caractéristiques de facilité de nettoyage et d'entretien ordinaire. C'est la raison pour laquelle il est fondamental que le nettoyage initial soit effectué immédiatement après la pose, en utilisant des produits à base acide, en frottant énergiquement et, par la suite, en frottant abondamment avec de l'eau. Il sera ainsi possible d'éliminer les résidus de mortier, d'adhésif, de ciment, etc. Il est possible d'utiliser tous les nettoyeurs disponibles sur le marché, à l'exception des produits contenant de l'acide fluorhydrique (composés et dérivés) comme le prévoit la norme EN 14411.
- Il est recommandé de protéger soigneusement le sol posé. S'il s'avère nécessaire d'exécuter d'autres opérations comme la peinture, les travaux de plomberie ou autre, une fois la pose terminée, nous conseillons de couvrir le sol avec des bâches en PVC ou AIRBALLS ou avec du tissu.

MANUTENZIONE E CURA

MAINTENANCE AND CARE / WARTUNG UND PFLEGE / ENTRETIEN ET SOIN

MANUTENZIONE E CURA Grazie al procedimento produttivo impiegato (alte temperature di cottura, materie prime di qualità e processo di sinterizzazione) la superficie dei materiali Ariostea è praticamente impermeabile (assorbimento d'acqua minimo). Per la manutenzione ordinaria si consiglia di utilizzare detergenti neutri privi di cere o prodotti ceranti onde evitare la formazione di strati untuosi, alternando se necessario saltuari lavaggi con detergenti alcalini in

concentrazione blanda ben sciacquati al termine.

Al fine di preservare le superfici dallo sporco e dalle lavorazioni di cantiere, a posa terminata le pavimentazioni, in particolar modo quelle realizzate con materiali levigati, devono essere adeguatamente protette con truciolare o altri materiali idonei. In tal modo sarà possibile evitare danneggiamenti provocati da lavorazioni successive.

MAINTENANCE AND CARE Thanks to the characteristics of the production process (high firing temperature, raw materials of great quality, sinterizing process), the surface of Ariostea material is waterproof (the water absorption is minimum). For standard maintenance we recommend to use neutral waxless detergents in order to avoid greasy films and to alternate, if necessary, with some occasional washings made with alkaline products in weak concentration

and abundantly rinsed at the end.

After the installation of floors, particularly of those made with polished materials, the surfaces should be adequately protected with particle board or other suitable materials in order to protect them from dirt and on-site processing.

This prevents damage caused by subsequent processing.

WARTUNG UND PFLEGE Dank des angewandten Produktionsverfahrens (hohe Brenn-temperatur, qualitativ hochwertiges Rohmaterial und Sinterung) ist die Oberfläche der Ariostea Materialien praktisch völlig wasserabweisend (minimale Feuchtigkeitsaufnahme).

Für die tägliche Unterhaltung empfehlen wir die Verwendung von neutralem Reiniger. Es ist davon abzuraten, wachshaltige Reinigungsmittel oder Produkte zum Einwachsen zu verwenden, um die Bildung von öligen Schichten zu vermeiden. Hin und wieder kann man bei Bedarf eine Reinigung mit einem in

Wasser verdünnten alkalischen Mittel durchführen, welcher nachträglich mit klarem Wasser sorgfältig abgewaschen werden soll.

Um die Oberflächen vor Verschmutzungen und Beschädigungen durch Bauarbeiten zu schützen, müssen die Bodenbeläge, insbesondere die aus geschliffenen Materialien, nach der Verlegung entsprechend mit Spanplatten oder anderen geeigneten Materialien abgedeckt werden. Auf diese Weise können Beschädigungen durch spätere Arbeiten vermieden werden.

ENTRETIEN ET SOIN Grâce aux caractéristiques du procédé de production (hautes températures de cuisson, matières premières de qualité et procédé de grésage) la surface des matériaux Ariostea est pratiquement imperméable (l'absorption d'eau est minimum). Pour l'entretien quotidien, nous conseillons d'utiliser des détergents neutres, sans cire ou produits de cirage, afin d'éviter la formation de couches de graisse. Si nécessaire, alterné des lavages occasionnel

avec des détergents alcalins abondamment dilués et bien rincés à la fin.

Après avoir achevé la pose des sols, notamment ceux réalisés avec des matériaux polis, il faut protéger comme il se doit, les surfaces contre la saleté et résidus de chantier, en appliquant des panneaux de particules ou autre matériaux similaires. Il sera ainsi possible d'éviter que les opérations suivantes n'abîment le carrelage.



ARIOSTEA HEADQUARTER

Castellarano, Reggio Emilia - Italy

www.ariostea.it

info@ariostea.it

Numero Verde
800-214252

CREDITS

Art direction: Marco Porpora, Mirco Natalini Marketing Ariostea
Graphic project: up-comunicazione.com

CAT01910

Printed in Italy - Edition: n.1 - March 2016

Ariostea all right reserved

WWW.ARIOSTEA.IT

Ariostea_via Cimabue 20 42014 Castellarano Reggio Emilia - Italy - Tel. +39 0536 816811 - Fax +39 0536 816838 (Italy) - Fax +39 0536 816858 (Export)